

PRACTICAL

ELECTRONICS

JUNE 1982

75p



Microsynth



MPG METER

Plus... SPECIAL SUPPLEMENT

SOUND SYNTHESIS TECHNIQUES



Microsynth...

Part One A.R. Bradford M.Sc.

ELECTRONIC sound synthesisers have become very popular over the last few years, with a wide range of ready built and do-it-yourself designs currently available. The problem is that they are all very expensive, although prices have been coming down slowly. Some manufacturers now produce small units for people not wishing to fork out several hundred pounds, but these all have drawbacks in terms of "cost-performance".

While "anything to anything else" patching (by matrix pin-patch or flying leads) is prohibitively expensive in small synthesisers, not to mention inconvenient, there is a tendency for simpler models to be rather limited in what they can do owing to the number of switched interconnections available. The Microsynth overcomes this limitation.

On the amateur constructor front, in the author's experience, there seems to be no limit to the complexity of existing designs, as if the designers' maxim were "never use simple circuits where something more complicated will do." This has resulted in an extensive re-think of what is required from the various units in a synthesiser with the emphasis on using as few and as cheap components as possible, while at the same time ensuring effective and reliable operation. Slide switches have been employed for the various interconnections; these work out just as cheap as flying leads and are a lot neater.

Ideally it should be possible to feed or modulate any part of the synthesiser from any other, but in practice many effects thus obtained are so dull or pointless as to be redundant. Consequently, much thought has gone into creating routing systems for audio signals and control voltages (the two may be the same) which is as versatile as possible, but which is greatly simplified by omitting the least useful connections, particularly where similar results may be obtained by more than one means. Having made sure of satisfying the experimenter, the author then consulted professional keyboard players in arriving at a panel layout which is both pleasing and ergonomic, that is, non-confusing and rapidly operated on stage.

Whilst the circuits employed in the Microsynth will obviously not compare with the most expensive instruments available, they will hold their own against many professional machines and are equally suited to domestic, stage and studio use. Most importantly, the Microsynth is completely insensitive to changes in temperature, that is, it will not go out of tune.

The result is a synthesiser which is tremendously versatile yet simple to operate, reliable, and above all cheap enough to bring the tremendous potential of electronic sound creation within the reach of most peoples' pockets!

PERFORMANCE

The Microsynth operates in two modes depending on the configuration of VCO2, as shown in the block diagrams (Figs. 1 and 2).

In the first mode both VCOs run at audio frequencies and manual modulation of pitch, etc, is available via the thumbwheel. In the second mode, VCO2 is configured as a

low frequency oscillator (LFO) and can be used to modulate the keyboard, filter, VCO1 mark/space, etc, trigger the envelope shaper, and so on. The thumbwheel can be used to introduce LFO modulation manually.

A notable feature of the Microsynth is that with VCO2 switched to "RM" or ring modulator mode, it still runs at audio frequencies and tracks VCO1 very accurately, but its output is via the modulation routes only. Thus instead of being added, the waveforms from the two oscillators are multiplied together producing sum and difference tones. This, together with the sub-octaves, underlies the remarkably rich sounds that the Microsynth can produce.

Having VCO2 switchable in this way is not a drawback as it may at first seem. In a unit as compact as the Microsynth it was felt that it was impractical to have a second VCO and an LFO and do justice to both, and so the switchable VCO is felt to be a reasonable compromise. Even with only one VCO operating the sub-octaves can be used to give rich harmonic structures, while waveform modulation or other effects are created by the LFO. Pitch bending can be introduced manually with the thumbwheel. With both VCOs running at audio frequencies the lack of a separate LFO makes little difference — the thumbwheel allows expression of various sorts to be imparted manually, while vibrato may be created by setting the two VCOs slightly apart to give a slow beat.

One feature of the Microsynth which is sadly lacking from many commercial designs is that all modulation routes enable the device being modulated to be swept over its entire range, enabling extreme effects to be produced. Another feature which is unusual in smaller synthesisers but which is very powerful, is the inclusion of a separate sample and hold (or analogue memory). This samples the waveform from VCO2 each time the envelope shaper completes a cycle and can be used to create either staircase or random



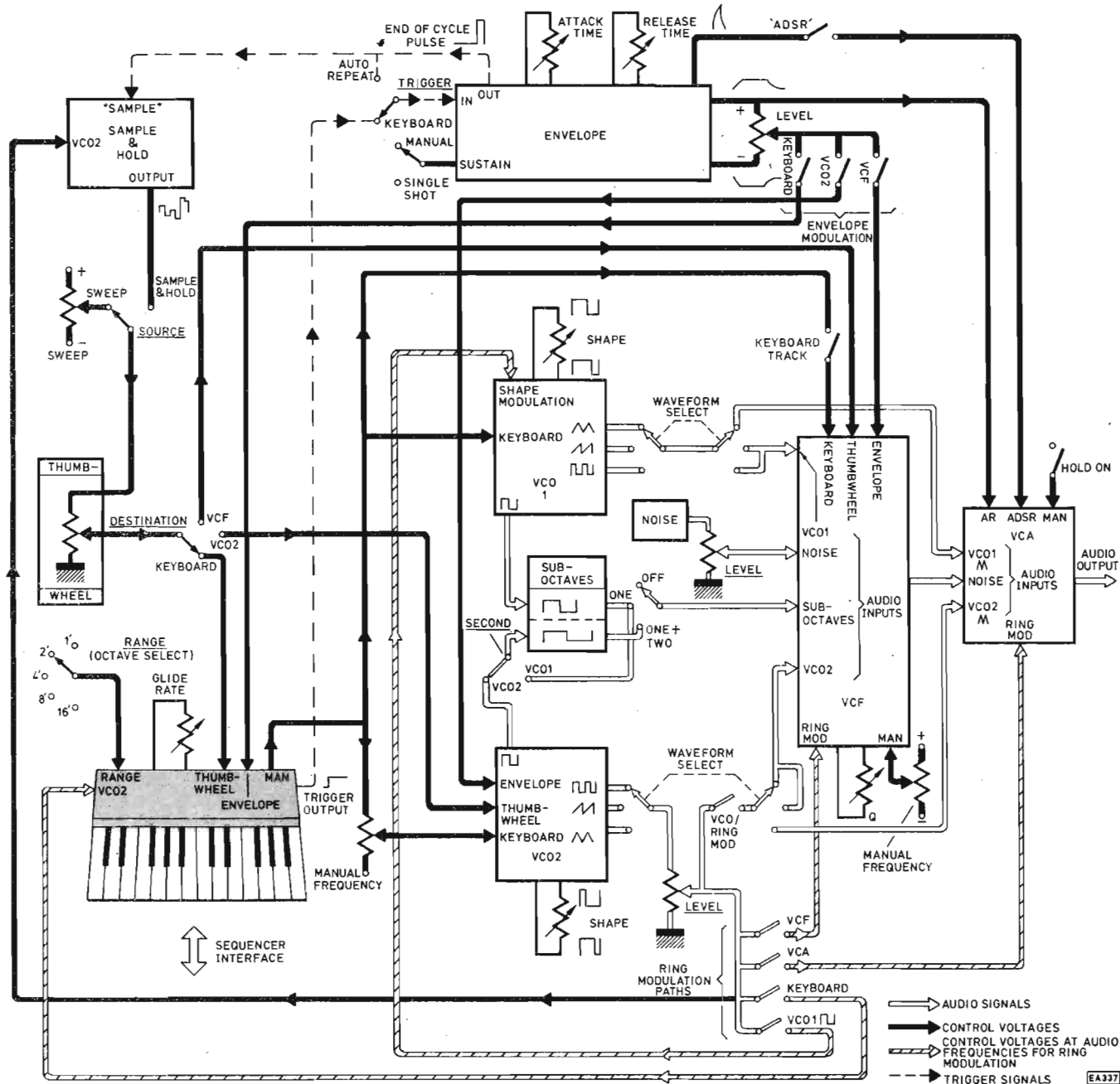

Fig. 1. Effective 2-VCO configuration of the Microsynth

changes in pitch or timbre. This enables the Microsynth to generate sophisticated rhythms or sequencer type patterns using the oscillators and/or filtered noise, which again far belie the complexity of the instrument.

KEYBOARD CONTROLLER

The keyboard resistor chain is in the feedback loop of IC1b, which acts as a constant current source giving highest note priority. The keyboard itself is provided with three contacts (made from short lengths of gold wire) under each key. As a key is pressed a sequence of two events occurs: first the selected point in the keyboard resistor chain makes contact with the keyboard bus bar which transfers the appropriate voltage to the sample and hold circuit IC4a, C1 and IC5a. A moment later the trigger bus is connected to the keyboard bus and switches on comparator IC1a, debounced by R28 and C2. As IC1a output goes high the CMOS analogue

switch IC4a is turned on and the keyboard voltage is sampled. As the key is released the trigger bus is disconnected first, so IC1a goes low, IC4a is switched off and the sampled voltage is stored on C1, buffered by high impedance op-amp IC5a. Finally the keyboard bus is disconnected.

IC1c and IC1d are wired as comparators of opposite polarity; each time the voltage from IC5a changes up or down, even by a semitone, this change in voltage is differentiated by C4 and R51 to give a spike, and this spike makes either IC1c or IC1d go high momentarily, depending on its direction. Thus a positive pulse appears on the far side of D2, D3, and this pulse enables the envelope shaper to be re-triggered each time a new key is pressed, even if the preceding key has not been released. This circuit comes into its own when fast runs are being played with a percussive attack.

The voltage from IC5a is summed along with an offset

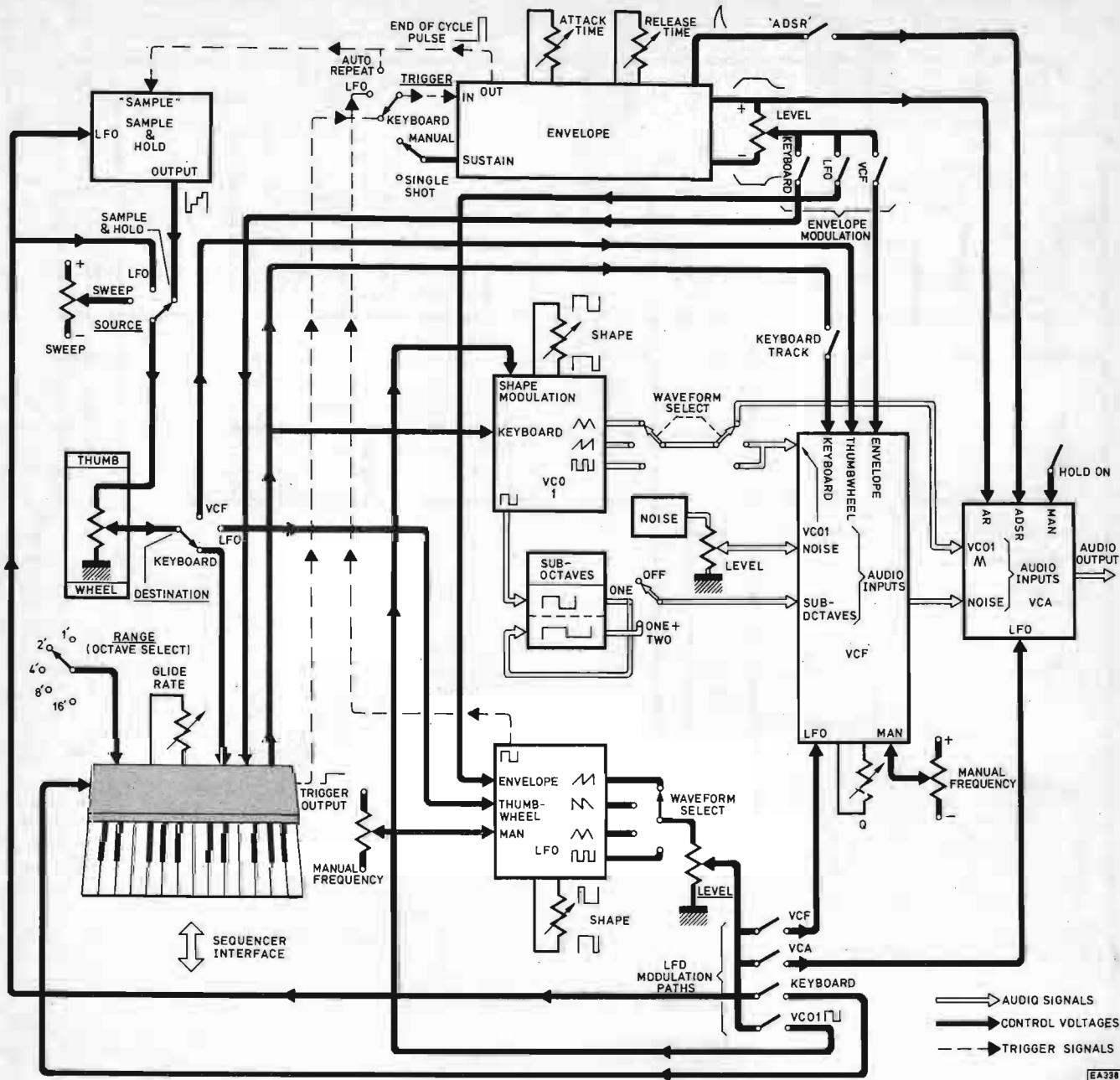

Fig. 2. Effective operation with VCO2 configured as an LFO

and various incoming modulation voltages by inverting amplifier IC2a. The voltage from the "Tune" preset VR1 is also fed in at this point. VR2, C5 and IC6 form a slew rate limiter providing glide rates from a few milliseconds to several seconds depending on the setting of VR2. Inserting the slew limiter at this point means that the transition to a new note will be completed even if the key is released prematurely.

The keyboard circuitry thus far generates a law of about 0.35 volt per octave. This is smaller than is commonly used in synthesisers for reasons which will become apparent.

EXPONENTIAL CONVERTER

This is the most important part of the synthesiser and will be discussed in some detail.

Positive going control voltages from the preceding circuitry are attenuated by VR3, R38, R39 and R40, so that

every 0.35 volt increment in input voltage results in an 18mV increment at the base of TR2, which in turn doubles the current flowing in TR2. The emitter of TR2 is held at -0.6 volt so that any positive voltage at its base will cause it to conduct. This reference voltage is generated by a temperature compensating transistor TR1, buffered by IC2b. As temperature rises the current in TR1 increases, raising the reference voltage and so lowering the current in TR2, and vice versa. D1 prevents zenering of TR1 and consequent damage. TR1 and TR2 are glued together for intimate thermal contact and a piece of polystyrene packing pushed over the two transistors ensures that they remain at the same temperature. In practice it has been found unnecessary to use specially matched transistors unless violent changes of temperature are anticipated.

The current to V_{be} relationship of TR2 is also temperature dependent affecting the relative tuning of the keyboard, or

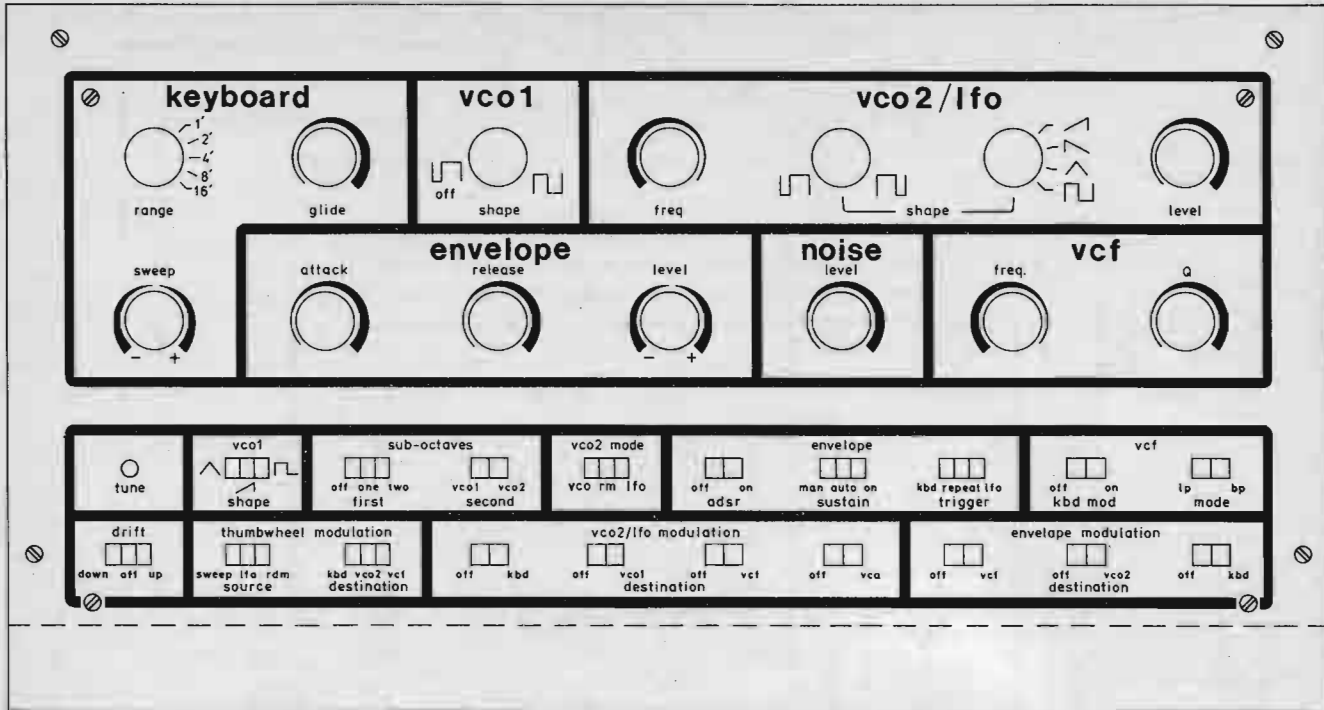

EA336

"span", as it is otherwise known, and so R39 and R40 are a combination chosen for a temperature coefficient which cancels out this effect.

The prototype Microsynth has been used for over a year both on stage and in the studio and invariably one finds that it is other, conventional instruments such as guitars that drift and require tuning, rather than the synthesiser. The prototype has also held its own against two expensive commercial machines—a Moog and an ARP. The circuit used here has advantages over other designs as the temperature stabilisation requires no tedious setting-up, there is no warm-up time (as with transistor ovens, heated chips, or whatever), and the musical scale is simply adjusted by VR3.

The current in TR2 is converted back into a voltage by IC7. This arrangement has been chosen so that more than one VCO can be driven from the same exponential converter. Thus only one converter is needed, reducing cost, and the musical scale of the instrument is adjusted only once. Another important advantage is that because both VCOs are driven from the same exponential converter, they will track each other perfectly over the entire range of the keyboard providing triangle/square wave VCOs are used, which unlike relaxation oscillators do not suffer from reset time problems. (Here it is worth noting that a defect of triangle oscillators is put to good use in the Microsynth, namely, a tendency to lock on to each other's harmonics). Octave switching is simply achieved by switching the gain of IC7 to multiply the exponential up and down. Thus the most accurate part of the exponential is always used. The octaves are tuned using VR4 to VR7, while VR8 trims out the offset in IC7, which must function linearly down to very low voltages.

DRIFT

One novel feature of the Microsynth is the "Drift" function. Moving S1 to the left or right means that once a key is released the held voltage (C1, IC5a) will drift up or down as C1 charges or discharges via R31 or R32 respectively. This offers a neat way of synthesising "seagulls", "frogs", "alarm" tones, etc, not to mention the sort of irritating noises heard on many disco records!

ENVELOPE

As previously described the envelope shaper is triggered each time a key is pressed, by IC1a. It can also be retriggered by pressing another, higher, key via IC1c and IC1d.

Moving S9 to the "LFO" position means that the envelope will be triggered by the square wave output from a slow-running VCO, for rhythmic effects. However the gating of IC3a and IC3b ensures that this only happens as long as a key is depressed. As the envelope output goes low the centre of the Schmitt trigger built around IC3c and IC3d goes high, and selecting the centre "Repeat" position of S9 sends this positive voltage back to the trigger input of the envelope shaper. Thus the whole thing is turned into an oscillator, retriggering itself every time it completes an attack and release cycle.

With "Sustain" switch S8 in the "Manual" position, pressing a key turns on IC4b while inverter TR3 holds IC4c off, so C12 charges up to about +8V via the attack pot VR9. Releasing the key reverses this arrangement: IC4b turns off and IC4c closes allowing C12 to discharge to -8V via the release pot VR10.

With S8 switched to "Auto", the set-reset flip-flop IC8c and IC8d is triggered as a key is pressed so that pin 10 of IC8 goes high, turning on IC4b and initiating the attack cycle. VR11 is adjusted so that when the envelope output (IC10 pin 6) reaches about +7V, the flip-flop is reset and C12 discharges via the release pot. The complete envelope cycle time is thus the sum of the attack and release times and one cycle occurs each time a key is pressed. IC9 and IC10 provide negative and positive going envelopes respectively. The positive going envelope is fed directly to the VCA, while "Level" control VR12 cross fades between negative and positive envelopes and controls the degree of modulation fed to the VCF, VCO2, etc. Diodes D8 and D9 provide a dead band in the centre of VR12, corresponding to 0 volts or "no modulation".

Each time the envelope shaper is triggered, by whatever means, the flip-flop built around IC8a and IC8b is set, charging up C11, and then reset by the voltage on C11 a short

COMPONENTS . . .

Resistors

R1		10k
R2		680
R3 to R26 (2%)		56
R27		1k2
R28		1M
R29		33k
R30		1k
R31, R32		10M
R33, R34		15k
R35		180k
R36		390k
R37		1M
R38		22k
R39	wire wound	870
R40	metal oxide	130
R41		39k
R42		22k
R43		47k
R44		100k
R45		180k
R46		390k
R47 to R50		10k
R51		15k

R52	100k
R53, R54	100
R55, R56	100k
R57	4k7
R58	33k
R59	100k
R60, R61	10k
R62, R63	10M
R64, R65	47k
R66	470k
R67	1M
R68	100k
R69	33k
R70	10k
R71	8k2
R72	4k7
R73	10k
R74	1k
R75	10k
R76	3k9
R77	470k
R78	1M2
R79	1M
R80, R81	470k
R82	10
R83	1M

R84	10k	R118	10k
R85	8k2	R119, R120	47k
R86	4k7	R121	1k
R87	10k	R122	33k
R88	1k	R123	3M9
R89	10k	R124	6k8
R90	15k	R125, R126	47k
R91	1k	R127	33k
R92	220	R128, R129	100
R93, R94	1M	R130	220k
R95	1k8	R131	1M
R96	100	R132, R133	10k
R97, R98	47k	R134, R135	68k
R99	5k6	R136	150k
R100	82k	R137, R138	1k
R101	47k	R139	100k
R102	5k6	R140, R141	10k
R103	33k	R142	39k
R104	1k	R143	15k
R105	220k	R144	2R7
R106 to R108	12k	R145, R146	0.5W 470
R109, R110	100	R147	4k7
R111	10k	R148	2k2
R112, R113	100	R149	10k
R114, R115	10k	R150	1M
R116, R117	4k7	R151	6k8
		R152	56k

Potentiometers

VR1	preset	100k
VR2	pot log	2M
VR3	cermet preset	22k
VR4	cermet preset	10k
VR5	cermet preset	10k
VR6	cermet preset	47k
VR7	cermet preset	47k
VR8	preset	10k
VR9	pot log	1M
VR10	pot log	2M
VR11	preset	100k
VR12	pot lin	100k
VR13	preset	10k
VR14	pot lin	100k
VR15	preset	100k
VR16	pot lin	1k
VR17	preset	10k
VR18	pot lin	100k
VR19	preset	100k
VR20	pot log	10k
VR21	pot lin	100k
VR22	preset	100k
VR23	pot lin	1k
VR24	pot log	10k
VR25	preset	100k
VR26	pot log	10k
VR27	edge pot log	4k7
VR28	pot lin	1k
VR29	preset	10k
VR30	preset	10k

Capacitors

C1	polycarbonate	1μ
C2	polyester	22n
C3	p.c. elec 25V	100μ
C4	polyester	100n
C5	polycarbonate	470n
C6	polyester	10n
C7	polyester	100n
C8	polyester	10n
C9, C10	polyester	10n
C11	p.c. elec 25V	1μ
C12	p.c. elec 25V	4μ7
C13	polyester	10n
C14	polyester	100n
C15	polyester	10n
C16	polyester	15n
C17, C18	polyester	10n
C19	polyester	15n
C20	polyester	10n
C21	polyester	100n
C22, C23	polystyrene	680p
C24	polyester	220n
C25	polyester	100n
C26 to C28	polyester	220n
C29	p.c. elec 10V	4μ7
C30	p.c. elec 35V	4μ7
C31	p.c. elec 10V	4μ7
C32	p.c. elec 25V	4μ7
C33	polyester	100n
C34	p.c. elec 25V	470μ
C35, C36	polyester	100n
C37, C38	p.c. elec 25V	200μ
C39, C40	p.c. elec 25V	10μ
C41, C42	p.c. elec 25V	1000μ

Semiconductors

TR1, TR2	BC182L
TR3	BC548
TR4, TR5	BC212L
TR6 to TR9	BC548
TR10, TR11	TIP41
D1 to D4	1N914
D5	0A81
D6 to D11	1N914
REC1, REC2	WQ05
IC1	4136
IC2	1458
IC3	4011
IC4	4016
IC5	LF347
IC6	LF351
IC7	741
IC8	4001
IC9 to IC13	741
	(5 off)
IC14	4016
IC15	LF351
IC16 to IC19	741
	(4 off)
IC20	LM13600
IC21	CA3080
IC22	4013
IC23	LM380
IC24, IC25	μA78MGU1C

Switches

S1, S3, S4, S6, S8, S9, S12, S13 are p.c.b. mounting slide switches 2-pole, 3-position (8 off)
 S4, S5, S7, S10, S11, S16 to S20 are p.c.b. mounting slide switches 2-pole, 2-way (11 off)
 S2, S21 are rotary switches, 2-pole, 6-way (2 off)

Miscellaneous

Transformer 0-12V, 0-12V 500mA, solder tag, Microsynth p.c.b. A (main board), Microsynth p.c.b. B (power supply and power amp), 25 note, flat fronted keyboard, Microsynth front panel, Microsynth socket panel, Microsynth cabinet, push-on knobs plus colour coded push in caps to taste, R.S. type (15 off), large edge wheel (at least 31mm dia), Microsynth keyboard,

p.c.b. gold contact wire (3m), mono jack socket open, stereo jack socket open, Din latch socket 5-pin A, min mains cable to suit, mains cable grommet ($\frac{1}{8}$ " dia), mains plug with 1A fuse, 2m of 4-way ribbon cable, Min screened cable (approx 0.5m), 6BA bolts $\frac{1}{4}$ " (10 off), 6BA nuts (10 off), 6BA threaded spacers $\frac{1}{4}$ " (6 off), 6BA threaded spacers $\frac{1}{2}$ " (4 off), domed-headed self-tap screws $\frac{1}{4}$ " (4 off), cabinet feet plus self-tapping screws to suit (4 off), strap handle.

Parts available from **Clef Products Ltd., 44a Bramhall Lane South, Bramhall, Cheshire, SK7 1AH.**

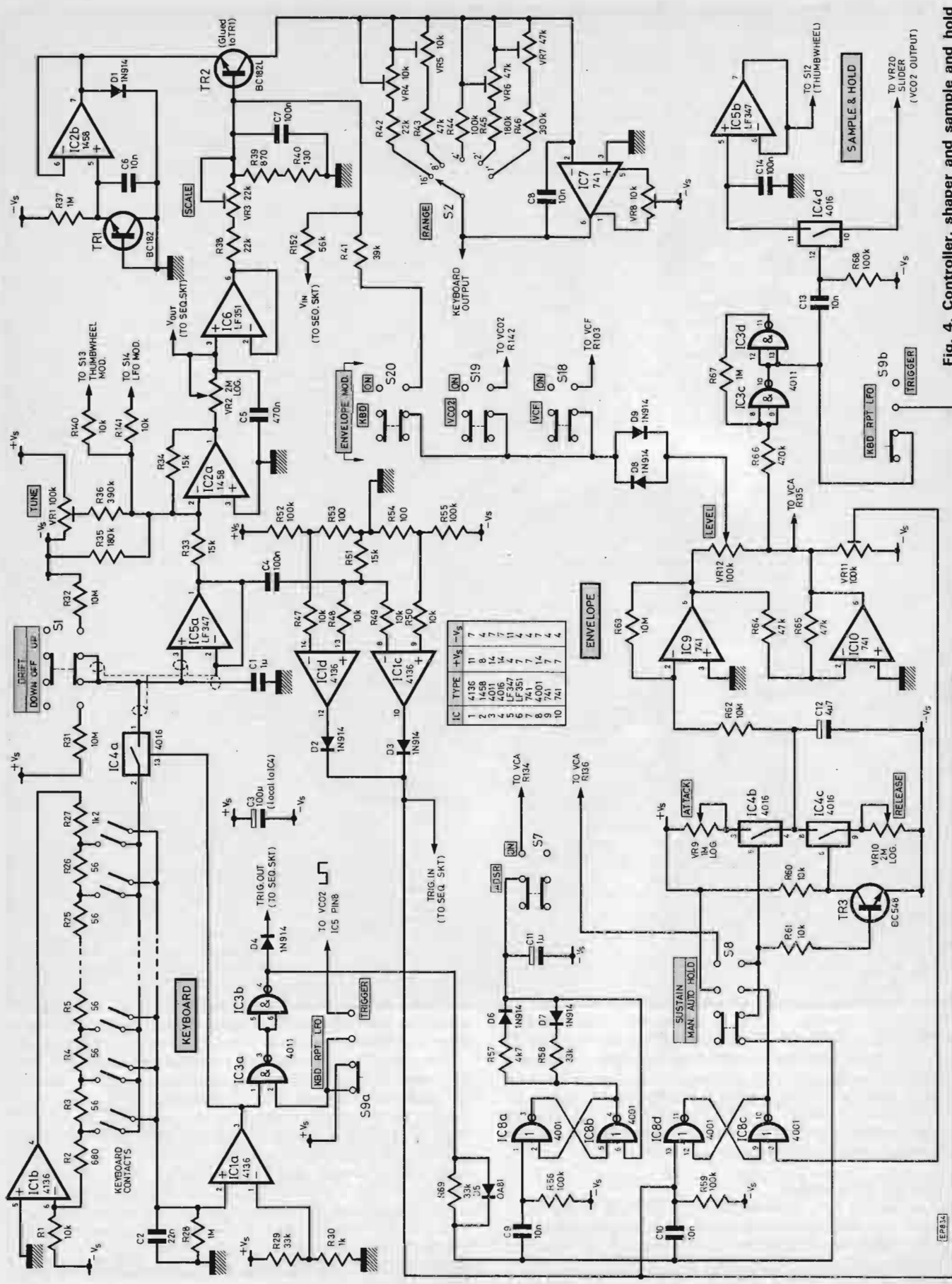

Fig. 4. Controller, shaper and sample and hold elements of circuit

SPECIFICATION

Keyboard	2 octave, may be stepped through 5 octave range from 16' to 1' using the "Range" switch. Debounced contacts. Max drift rate about ten minutes per semitone. "Drift" switch allows selected note to drift up or down once a key is released at about 1 octave per second. "Glide" variable 0 to 5 seconds. Front panel screwdriver adjustment "Tune" allows tuning of the synthesiser relative to other instruments over $\pm \frac{1}{2}$ octave. Modulation by any or all of Sweep, VCO2/LFO, Envelope, Sample and Hold. High note priority.
VCO1	10Hz to 10kHz nominal range, hardwired to keyboard. Triangle output to VCA, ramp and squarewave outputs to VCF. Duty cycle of squarewave variable from 50% to 10% either manually or by VCO2/LFO. May be switched off, allowing VCO2 or Noise to be used alone.
VCO2/LFO	VCO mode: 10Hz to 10kHz nominal range. Frequency may be manually set to any multiple of VCO1 frequency. Accurate tracking over entire range of keyboard. Triangle output to VCA, rising ramp, falling ramp or squarewave to VCF. Squarewave duty cycle manually variable from -10% through 50% to +10%. Level control on output. Ring mod mode: Switch disconnects audio outputs but LFO modulation switches allow frequency modulation of keyboard, VCO1 shape, VCF, VCA. In either mode, independent modulation allows pitch bending relative to VCO1 by any of sweep, envelope, sample and hold. LFO mode: 0.1Hz to 30Hz nominal range, manually variable. Manual level control, triangle, rising ramp, falling ramp and squarewave modulation via output switches to keyboard, VCO1 shape, VCF, VCA. Modulation of LFO frequency by sweep, envelope, sample and hold.
Sub Octaves	Two divide-by-two circuits may be used to provide either an octave below VCO1 frequency and an octave below that, or an octave below each of VCO1 and VCO2, switchable. Outputs: squarewave to VCF.
Noise	White noise source with level control. Output to VCF.

Envelope

Attack and release times variable 0 to 10 seconds. ADSR switch adds additional percussive attack. Triggered either from keyboard, or LFO as long as a key is depressed. Repeat switch causes the envelope shaper to retrigger itself, with a repeat time equal to the sum of the attack and release times. Sustain operates in three modes: "Manual" means the envelope attacks and remains high as long as a key is depressed (like an organ); "Auto" puts it into single shot mode so that depressing a key produces one attack and release cycle. The envelope is then only retriggered by re-pressing the same key or depressing a higher key; "Hold" produces a continuously audible output about half maximum volume — pressing a key then adds the envelope shape to this constant level bringing the output of the VCA up to maximum. The positive-going envelope is hardwired to VCA; positive and negative envelopes are available via the level control for modulation of any or all of keyboard, VCO2/LFO, VCF.

VCF

State variable filter with manual control of roll-off frequency. Outputs: switchable low pass or band pass to VCA. Manual "Q" control adjusts size of resonant peak at roll-off frequency. Min roll-off: 6dB per octave; max roll-off: 50dB per octave. Modulation of roll-off frequency by keyboard, envelope, sweep, VCO2/LFO, sample and hold.

VCA

Controls output volume of synthesiser. Max attenuation: -60dB min. Max output level 100mV into 10k Ω , via master volume control on rear panel.

Sample and Hold

Analogue memory samples instantaneous output voltage from VCO2/LFO each time envelope ends. Output to thumbwheel.

Sweep

Manual control producing variable positive or negative d.c. control voltage with zero dead band at centre. Output to thumbwheel.

Thumbwheel

Manual level control. Modulation depths may be preset using sweep and VCO2/LFO level controls, then introduced manually using the thumbwheel. Inputs: sweep, VCO2/LFO or sample and hold. Output to keyboard, VCO2/LFO or VCF.

Power Amp Sequencer Socket

Output 2 watt into 8 ohm nominal. Keyboard output voltage 0.35 volts per octave. Trigger output voltage 9 volts positive. Input requirements 0.35 volts per octave to keyboard, 9 volts positive trigger to envelope.

time later. In this way a pulse, shaped by R57, D6, R58, D7, is produced. Closing S7 adds this pulse into the VCA, giving an added percussive attack, and simulating a full ADSR envelope. While this is a bit of a cheat to keep costs down, one finds in practice that if one goes to the trouble of building an ADSR envelope shaper, most of the time it will be used to create precisely this sort of envelope, with only the sustain and release times being altered.

SAMPLE AND HOLD

The remaining f.e.t. op-amp from IC5 (pins 5, 6 and 7) is used to form a separate hold circuit. Each time the envelope shaper completes a cycle, the positive pulse from IC3c (pin 10) passes via D10, C13 and R68, and closes CMOS switch IC4d for a few milliseconds. In this way the selected

waveform from VCO2/LFO is sampled and held on C14, buffered by IC5b.

The output from the Sample and Hold can be fed into the keyboard via the thumbwheel in order to produce "random" or "staircase" changes in VCO pitch depending on the frequency of VCO2/LFO relative to the sampling frequency. That is, a slow waveform from the LFO, sampled fairly quickly, will give a staircase effect. If VCO2/LFO frequency is considerably faster than the sampling time, then the changes in pitch will be apparently random. Alternatively with VCO1 off, and VCO2 running as an LFO, noise being fed into the VCF and the VCF tracking the Keyboard, similar effects can be achieved with filtered noise.

NEXT MONTH: VCOs, VCF, VCA, power amplifier and power supply.

Microsynth...

Part Two A.R. Bradford • M.Sc.

In this part more of the circuitry will be described together with assembly details of the main board and power amplifier.

VOLTAGE CONTROLLED OSCILLATORS

The VCOs are built around a fairly standard triangle/square oscillator, configured for voltage control.

Consider VCO1: assume IC14b is open, then a positive control voltage applied to the input network (R70 to R73) will cause integrator IC11 to ramp negatively until it reaches the negative threshold of Schmitt trigger IC5d. The Schmitt then switches hard positive, turning on IC14b and removing control voltage from the inverting input of IC11. The input voltage is still connected to the non-inverting input however, so the integrator now ramps positively until the Schmitt flips negative again, and so on. IC5d need not be a high impedance type, yet it so happens that the chip used for the VCO Schmitt triggers and for the sample and hold circuits has a high slew rate of 13V/ μ sec. Using a 741 in this application results in the VCO going alarmingly flat at high frequencies!

Comparator IC12 compares the triangle waveform with a reference voltage set by VR14, in order to generate a square wave; varying VR14 changes the duty cycle, or mark/space ratio of this square wave, which in turn varies the harmonic content of the sound. In VCO1 this may be done automatically by applying a modulation voltage to R79 for phasing effects. R77 attenuates the squarewave to the same level as the other waveforms.

Generating a ramp or sawtooth from a triangle waveform can be very complicated, but here a novel system is employed. The input control voltage is also fed via R76 to a second integrator IC13, which ramps negatively until C17 is discharged by a pulse from IC5d momentarily closing IC14c. Thus a secondary or slave relaxation oscillator is formed, with its frequency permanently phase locked to that of the triangle/square master oscillator. In this way reset time problems are eliminated—only the amplitude of the ramp waveform changes with frequency, and in practice this change is so slight as to be unnoticeable (unlike slight changes in pitch!)

Nulling out the offset on integrator IC11 by means of VR13 enables the VCO to remain in tune with very low input voltages, thus expanding the usable range of the VCO down to less than 100Hz.

VCO2: IDENTICAL FUNCTION

VCO2 (IC15 etc) functions identically, except that in its LFO mode it will oscillate down to about 0.3Hz, and possibly as low as 0.1Hz. The lowest frequency may be obtained by carefully selecting R82. In VCO2, the ramp integrator IC16 is biased by R95 and R96 so that its output waveform is symmetrical about ground, and IC17 is added to provide a sawtooth of opposite sense. VR16 attenuates the input

voltage to VCO2 and so determines its frequency. Rotary switch S21 selects the output waveform and VR20 controls the level. With S6 in the LFO or RM positions, the output is disconnected from the audio signal paths and the output may be routed through any of S14 to S17. With S6 in the VCO position, S21b sends the ramp or square wave outputs to the VCF, but the triangle is sent directly to the VCA. This is done because a triangle contains very few harmonics and thus sounds smooth—almost like a sinewave only more interesting, and so is not filtered. Doing this leaves the VCF free to filter the squarewaves from the sub octave generators. The triangle output from VCO1 is similarly fed directly into the VCA via waveform select switch S3.

SUB OCTAVES

There would be no excuse for not including a circuit which is so simple yet which has such a dramatic effect on the sound potential of the synthesiser. IC22 is a dual J-K flip-flop wired as two divide-by-two circuits and driven by the squarewave from one or both VCOs. Thus it can be used to generate either an octave below the frequency of VCO1 and/or an octave below that (selected by S4), or an octave below each of VCO1 and VCO2 (selected by S5). The resulting squarewaves are fed into the VCF.

As stated above, the VCO triangle outputs, when selected, are fed directly into the VCA, leaving the filter free to smooth out the tone of the sub octaves. In this way four-note chords may be generated from a single key, giving rise to the remarkably full sound of the Microsynth. Indeed, the variety of waveforms which can be used and added, or multiplied together is probably the strongest point of this instrument, for example, it can create remarkably rich church organ type sounds, particularly when reproduced through a good quality amplifier and speaker.

VOLTAGE CONTROLLED FILTER

IC20 is a dual operational transconductance amplifier (OTA) and is configured here as a state variable filter providing low pass and band pass outputs. The operation can be understood by considering each half of IC20 as a non-inverting integrator, the time constant of which depends on the control current flowing into the bias inputs of the OTAs (pins 1 and 16).

The control current is sourced by another exponential converter, TR4, TR5 and IC19, in order that the filter should track the VCOs. The "law" of this converter is not accurate enough to drive VCOs, but is quite adequate for the VCF. This is because slight changes in harmonic content of a sound go undetected, whereas slight changes in pitch are very noticeable. Again, TR4 and TR5 are glued together for thermal stability.

The bandpass output from pin 8 of IC20 is fed back to the signal input via VR23, producing a resonant peak in the response of the filter. It is this resonant peak which produces the characteristic synthesiser "Waa-Waa" sound, as it is

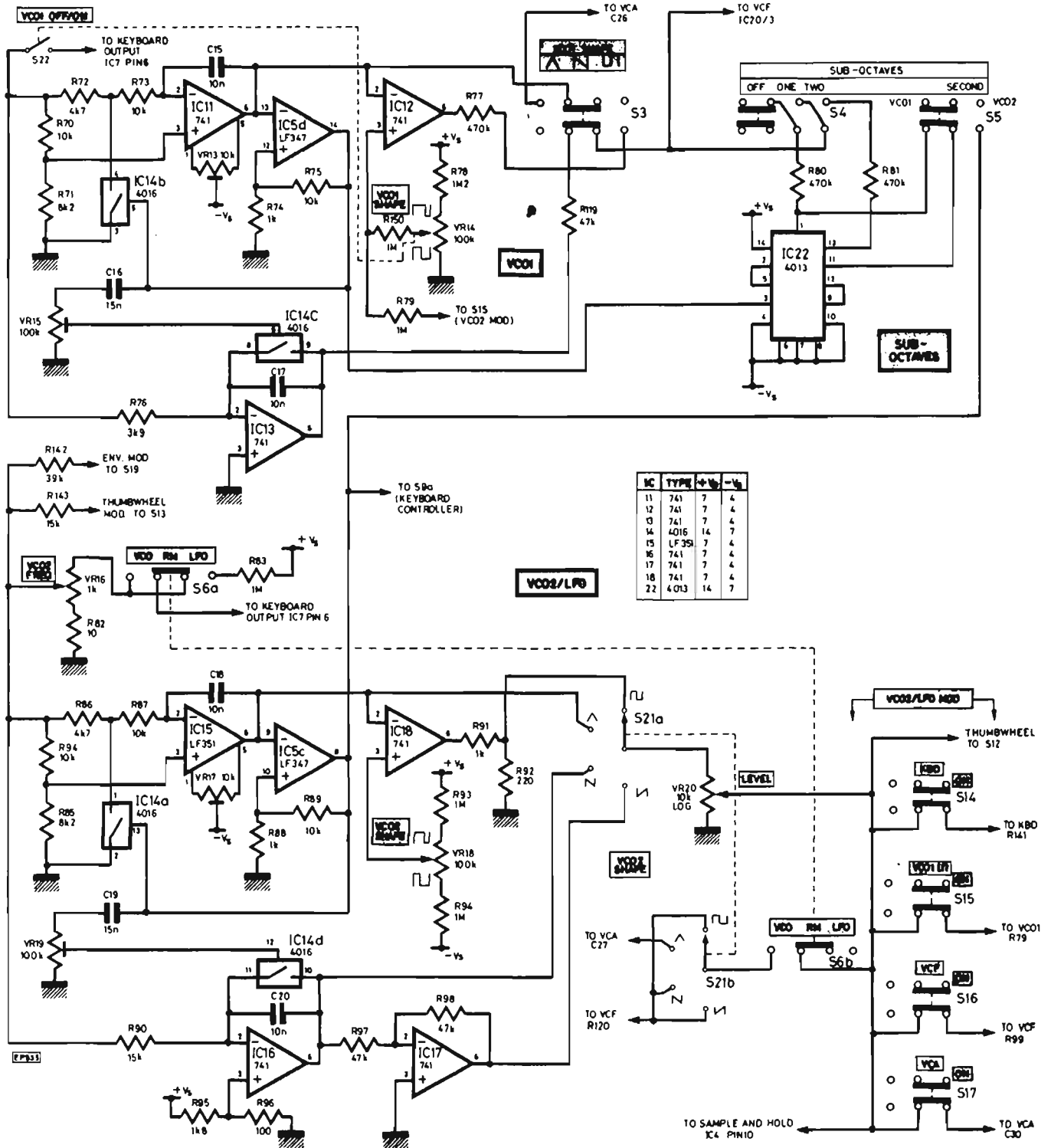

Fig. 5. VCOs and sub octave generator

swept through the harmonics of a VCO waveform. It also creates wind effects when the VCF is fed with white noise.

The frequency at which the VCF begins to cut off is set by VR21, but this frequency is modified by the various modulation inputs. In particular the envelope can be used to create the "Waa-Waa" effect as keys are depressed, and moving

S10 to the "On" position enables the VCF to track the keyboard voltage, to a degree set by VR22. In practice, VR22 is adjusted so that using the band pass output and a noise input, a tune can be played from the keyboard consisting of filtered "whistles". The "Q" control VR23 must be set at maximum for this.

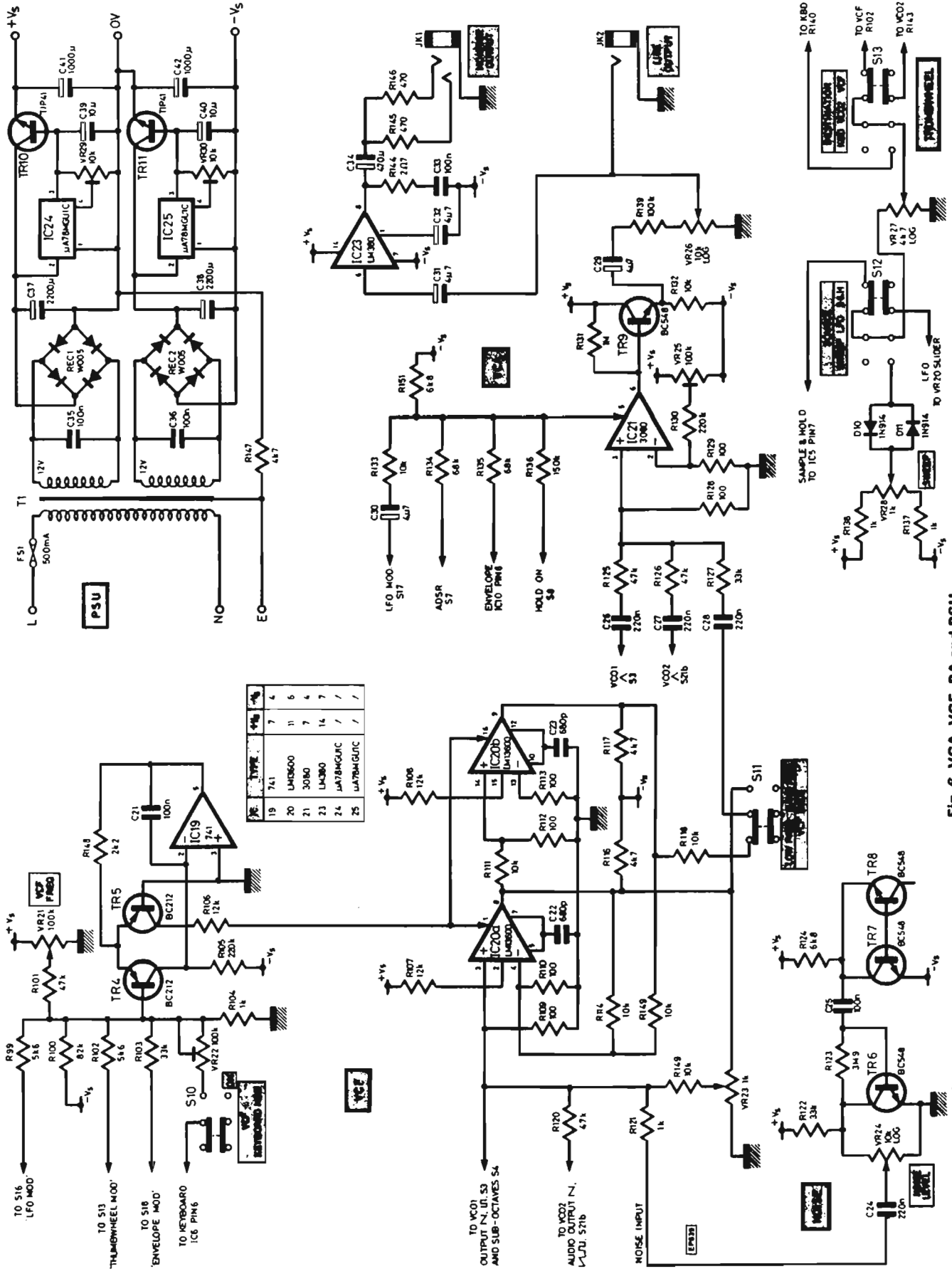

Fig. 6. VCA, VCF, PA and PSU

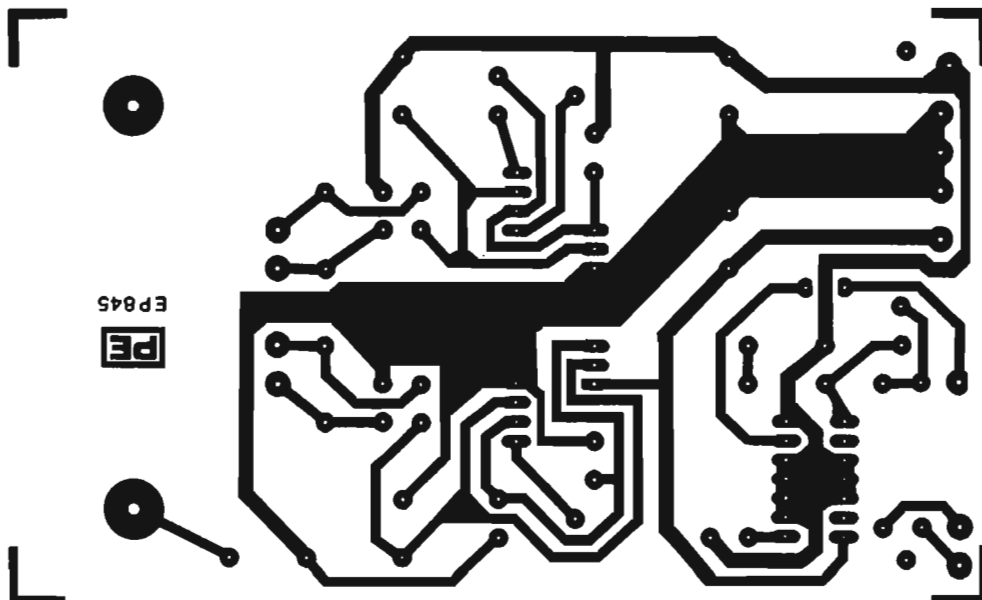
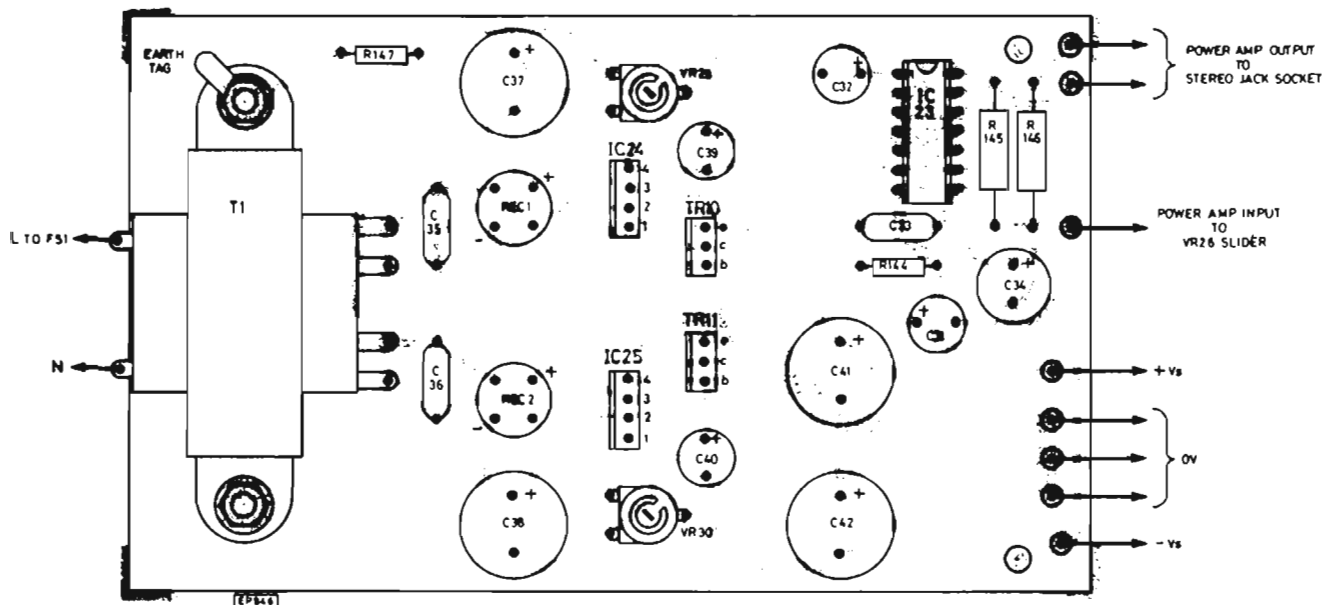

Fig. 7. (Left) printed circuit of power supply

Fig. 8. (Below) component layout of PSU board



NOISE

There seemed little point in following the trend for using shift registers with feedback to generate digital pseudo-random noise, when an ordinary type reverse-biased transistor (TR8) will generate real random noise at a fraction of the cost. TR6 and TR7 amplify this noise up to a usable level and VR24 controls the noise level fed to the VCF. Frequency analysis revealed the noise spectrum to be of reasonably constant amplitude at all audio frequencies.

VOLTAGE CONTROLLED AMPLIFIER

Another OTA IC21 is used in a circuit similar to the filter, except that here there is no time constant involved, so that the current flowing into the bias input simply modulates the amplitude of the input signals. Preset VR25 is adjusted to minimise breakthrough of the control signal. TR9 buffers the output, and VR26 is the master volume control for the synth.

THUMBWHEEL

This is simply an edge potentiometer located alongside the keyboard. It allows the musician to impart greater expression to his playing in several ways, for example by sweeping the VCOs' pitch to any degree up or down, preset by the voltage from the sweep pot VR28. D11 and D12 again provide a dead band at the centre of VR28 corresponding to zero modulation. Alternatively the pitch of VCO2 relative to VCO1 could be bent in this way, or the roll off frequency of the filter, for a manual "Waa-Waa" effect.

The thumbwheel may also be used to introduce LFO modulation (or ring modulation) to a level preset by the VCO2/LFO level control VR20, routed into either the keyboard or VCF via S13. The output of the Sample and Hold is also routed via S12 and the Thumbwheel.

This is a feature normally found only on the more expensive machines.

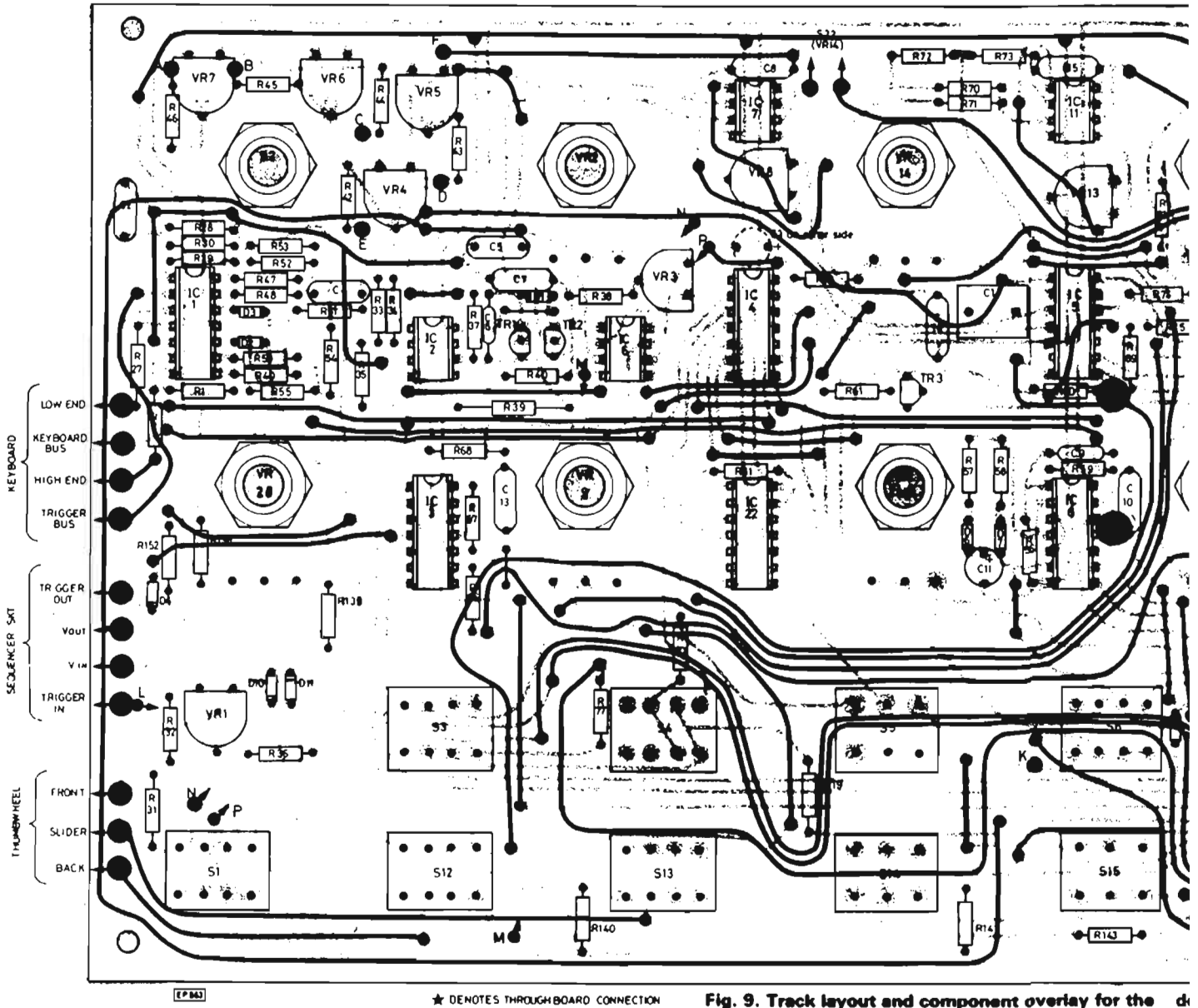

Fig. 9. Track layout and component overlay for the d

POWER AMPLIFIER

IC23 is a monolithic amplifier providing nominally 2 watt into 8 ohms, and will drive normal stereo headphones, although a loudspeaker could also be driven. The output load resistors (R145, R146) are duplicated so that if a loudspeaker is connected using an ordinary mono jack plug, the output will not be shorted.

POWER SUPPLY

There is nothing quite like a synthesiser for amplifying

defects in a power supply, since inability to supply the requisite current on demand results in alarming changes of VCO pitch, not to mention oscillator breakthrough, clicks as circuits change state, and so on.

To overcome these problems the circuit shown here employs two monolithic i.c. regulators (IC24 and IC25) driving the bases of two power transistors (TR10 and TR11). The output voltage of the positive and negative rails is set relative to 0V by presets VR29 and VR30 respectively. Ample smoothing is essential, in the form of C37 and C38. C35 and C36 reduce mains spikes which can cause spurious triggering of the envelope shaper, and C41 and C42 are there to reduce oscillator breakthrough on the power rails.

WARNING

Under no circumstances should the rails be set to greater than $\pm 9V$. A total of 18V is as much as the CMOS chips can take, which, for simplicity of design, are run directly across the positive and negative rails. This setting up should be done before any CMOS chips are inserted on the main board.



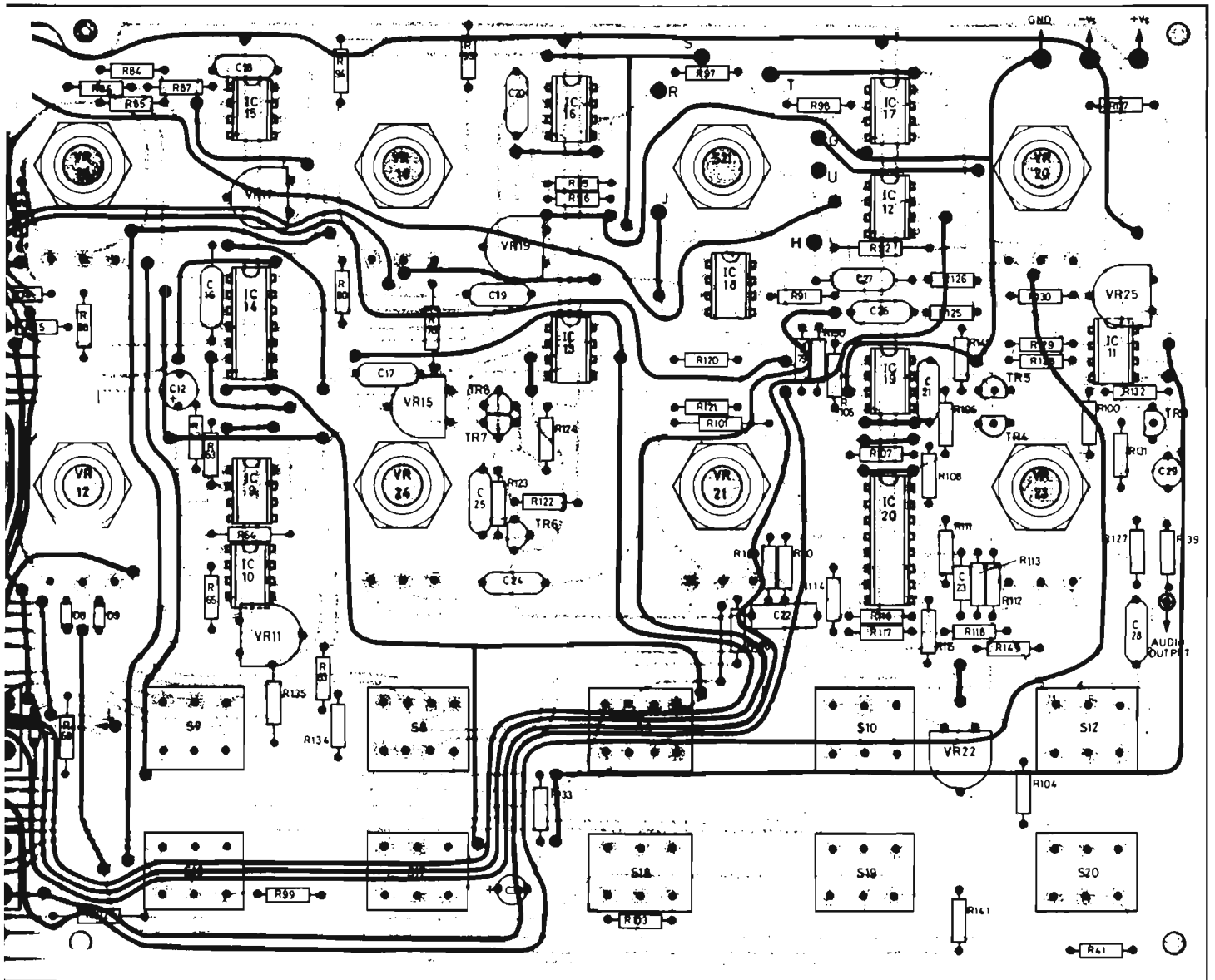

double sided main board. Here the board topside is coloured and the underside etching tinted

CIRCUIT BOARDS

Working from the top side of the main p.c.b., solder pins into all the holes in the tracks on this side, then turn over the board and solder the other ends of all these pins. Check to make sure none have been missed. This completes the links from one side of the board to the other.

Next assemble the board in the usual manner: wire links and resistors first, followed by capacitors, presets, semiconductors. Pins should be used for all the off-board connections. Low profile d.i.l. sockets should be used for the CMOS i.c.s, and for preference, all the i.c.s. Solder the slide switches in using the $\frac{1}{8}$ in. spacers. Finally mount the pots and rotary switches from below the board, having first cut the spindles to 1 in length, and solder the pot pins directly to the pads on the p.c.b. The rotary switches are wired to the appropriate pins on the board with short flying leads. Long wire links are denoted by letters at each end, that is, connect "L" to "L", "M" to "M", etc.

Thoroughly inspect the board for shorts, etc, then scrub the underside and re-check. Double check all components against the schedule.

Similarly construct the power supply p.c.b.

SETTING UP

First check the power supply, setting the outputs to $\pm 8V5$ using VR29 and VR30. Connecting the power supply to the main p.c.b., if there is any drastic departure from the nominal supply voltages switch off at once and recheck the board for shorts, incorrect (that is, too small) resistors, etc. If all is well, retrim the power supply to exactly $\pm 8V5$ and proceed.

Start with all switches to the left except "Drift" which should be "Off" (centre position). Set the range switch to 4', Sweep and Envelope Level to mid-way, and the thumbwheel fully towards the front. Attack, Noise Level, VCO2/LFO level and Q should all be at minimum. Set Release one quarter up and VCF frequency full up and connect the output to an amplifier, making sure the volume control on the back panel is full up. Pressing any key should enable the triangle waveform from VCO1 to be heard. Shape controls should be midway.

With the range control at 4', the octaves of the keyboard are first tuned relatively, against pitch pipes, ear, DFM, guitar, or whatever is available, using VR3.

Next Month: Setting up the synthesiser with test programs.

Microsynth...

Part Three A.R. Bradford M.Sc.

In this final part setting up of the synthesiser will be covered together with a series of test programs. Case construction is also covered.

VCOs

Selecting the square wave output from VCO1, take VCO1 down to its lowest frequency by pressing the lowest key, setting the Range switch to 16', and then using the Sweep pot routed via the thumbwheel into the Keyboard, so that VCO1 is just oscillating. Adjust VR13 for the fastest buzz. Reduce frequency again using the thumbwheel and readjust VR13 for the fastest ticking. This process has nulled the offset on VCO1 integrator IC11, enabling the oscillator to stay in tune for very low input currents. Switch off VCO1 using the switch on the "Shape" pot and turn the thumbwheel to zero (towards the front). Repeat the above process for VCO2, selecting the square wave output and using the VCO2 frequency control and adjusting VR17. Remember to turn VCO2 Level up.

The ramp waveforms from each VCO are now adjusted in turn. Turn VCO2 Level down and switch VCO1 on. Selecting the ramp waveform from VCO1 sweep the oscillator over its entire range using the Range switch and the Sweep/Thumbwheel combination, and adjust VR15 to ensure that the output does not disappear or become distorted at either end of the range. An oscilloscope is useful here but by no means essential. Repeat the process for VCO2 adjusting VR19.

Next, using VCO1 at the low end of its range (16'), play a scale; this should be in tune, so bend the frequency down very low using the thumbwheel and adjust VR8 for an accurate scale. This process nulls out the offset on the keyboard range amplifier, IC7.

OCTAVES

Now the octaves may be set up using the keyboard and the Range switch. Working either side of the 4' range, which requires no adjustment, set the ranges an octave apart by adjusting VR5 and VR6 (8' and 2' respectively), followed by VR4 and VR7 (16' and 1' respectively).

Tuning of the whole instrument relative to another instrument is achieved by turning VR1.

VCF

Select a ramp waveform from VCO1 and switch the VCF "Kbd Mod" on. Set the VCF frequency control half way thus filtering the ramp waveform down to a smooth tone and sweep the keyboard using the range switch. VR22 should be adjusted so that there is no obvious change in harmonic content as the keyboard is swept. Switch both VCOs off and turn up the Noise Level control. With the Q control at maximum it should now be possible to play a crude scale of whistles from the filtered white noise.

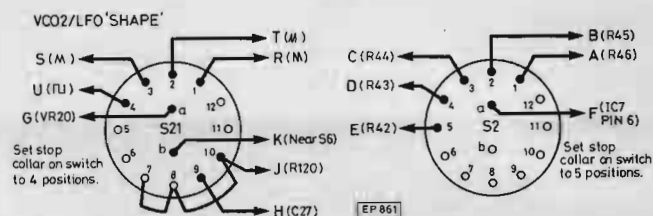

Fig. 10. Wiring of rotary switches viewed from underside of main p.c.b.

ENVELOPE

Set the Attack and Release controls about one quarter turn, and switch the Envelope Shaper to "Auto" using S8. Upon pressing a key the output may latch up (not decay away once the Attack cycle has been completed). If this is the case turn VR11 anti-clockwise until the sound dies away again. If VR11 is too far anti-clockwise, the output volume in "Auto" mode may be appreciably quieter than in "Manual" mode. Therefore turn VR11 clockwise to equalise the output volume in the two modes of operation, but making sure that the envelope resets correctly without latching up. Check also that the 'Repeat' functions. If not turn VR11 clockwise. Finally, each time a key is pressed there will probably be a thump at the output; this should be nulled out using VR25.

FAULT FINDING

Assuming there are no faults up to now the Microsynth should be set up and ready for use. If the VCOs malfunction for no apparent reason, it may be that CMOS chip IC14 has been damaged by static during insertion. Replacing this chip usually cures such inexplicable faults. It now remains to test out all the various functions of the Microsynth. It is

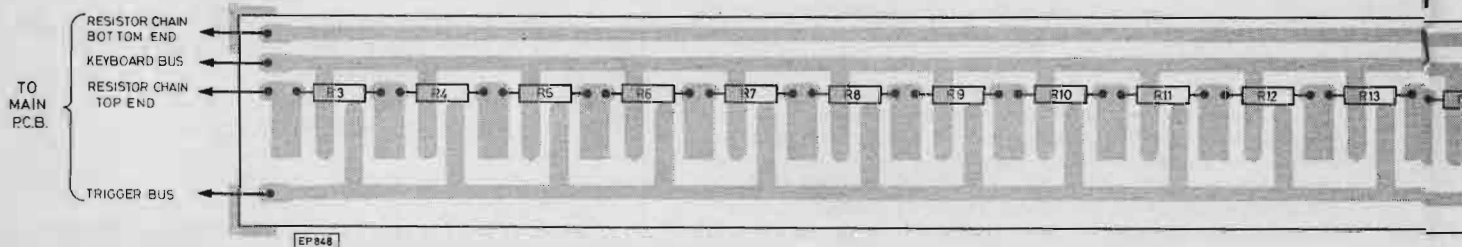

Fig. 11. Showing copper side of keyboard p.c.b.

suggested that the test programs listed below are run through—if these all work it is unlikely that there is anything wrong with the circuitry.

Should any function fail to work, check the p.c.b. against the component schedule and circuit diagrams, inspecting the relevant area of the p.c.b. for incorrect components, dry joints, solder bridges, diodes or transistors in the wrong way round, etc. Where one part of the synthesiser is connected to another some distance away, follow the relevant tracks making sure that there are no breaks, shorts, pins missing, etc, in these links. 99 per cent of all faults can be isolated in this way and will generally be found to be due to some trivial mistake in construction.

TEST PROGRAMS

Set all function switches (except "Drift") to the left between programs.

Star Wars

Switching VCO2 to LFO mode disables the audio output and sets the operating range from about 0.1Hz to 30Hz. The LFO may be used to sweep the keyboard automatically; use the ramp waveform from VCO1 and try the effect of the various waveforms available from VCO2/LFO. Route the LFO output either directly into the Keyboard using S14, or via the thumbwheel, setting "Source" to "LFO" and "Destination" to "KBD". Use the square wave from the LFO in conjunction with the "Shape" control to vary the duty cycle.

Waa-waa

Switch the Envelope output into the VCF. Set the Q control about two thirds up and VCF Frequency fairly low; set Envelope Level about half way positive. Keep Attack and Release times fairly short and remember to only use VCO waveforms with a high harmonic content, that is, ramp or square waves. You should now have the typical Moog sound. A slightly longer Attack and shorter Release and you will start to get a trumpet-like voice. Try switching in some Sub Octaves at this point!

Wind

Disable both VCOs and turn up the Noise Level control. With the VCF Q knob set fairly high and the low pass output selected, varying the VCF Frequency control will generate wind effects. Switch the VCF output to band pass and get rain too! Try the envelope on "Auto" and "Repeat" (or alternatively triggered from a slow-running LFO) for generating percussive, rhythmic effects—steam trains are quite easy using a repeat time of about 0.3 seconds and suitably short Attack and Release times. Don't have the Q control too high though. Alternatively, turn the Attack and Release times right round to maximum and switch the Sustain to "Hold". Use the "Repeat" facility rather than LFO triggering. Q low, VCF frequency mid-way, and a small positive Envelope Modulation in to the VCF and you will start to get a seascape. When you are happy with this, turn VCO1 on with

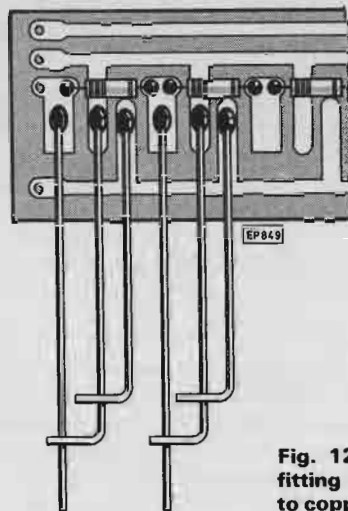

Fig. 12. Showing method of fitting key contacts (soldered to copper side)

a triangle output, switch the Range to 2' and the "Drift" switch to "Down". The repeatedly hit keys at random for the complete treatment.

Bells

Using the triangle outputs from both VCOs, switch VCO2 to "Ring Mod" and switch VCO2/LFO modulation into the VCA. Pressing a key and bringing up the volume of VCO2 will gradually introduce sum and difference tones. Set VCO2 at some anharmonic ratio of VCO1's frequency. Switch the Envelope to "ADSR" and sustain to "Auto" with short Attack and fairly long Release times. Alternatively use VCO2 in LFO mode to modulate the keyboard with a slow, low amplitude triangle (vibrato!). Note that the LFO speed can be changed by the Envelope as it rises and falls (switch Envelope Modulation into VCO2) so that the speed of the vibrato is fast to start with and slows as the envelope dies away, or vice versa. Try the effect of the sub octaves with VCO1

Organ

The use of triangle oscillators to provide relatively pure tones, while the VCF filters other waveforms (in this case the Sub Octaves, one each under VCO1 and VCO2), really comes into its own with this program. Switch the "ADSR" off, Sustain to "Manual", with Attack and Release times short. Tune VCO2 to, say, an octave and a third below the pitch of VCO1, and there you have it!

Random/Staircase

Have the envelope repeating at a fairly brisk rate (remember to have the Sustain on "Auto" for this effect to work; with Sustain on "Manual" and the "Repeat" on you will get a sort of echo every time you release a key!) and switch the thumbwheel Source to "S & H" (Sample and Hold). Push the thumbwheel fully up. Route the thumbwheel output into the keyboard. With VCO1 and VCO2 tuned to some interval

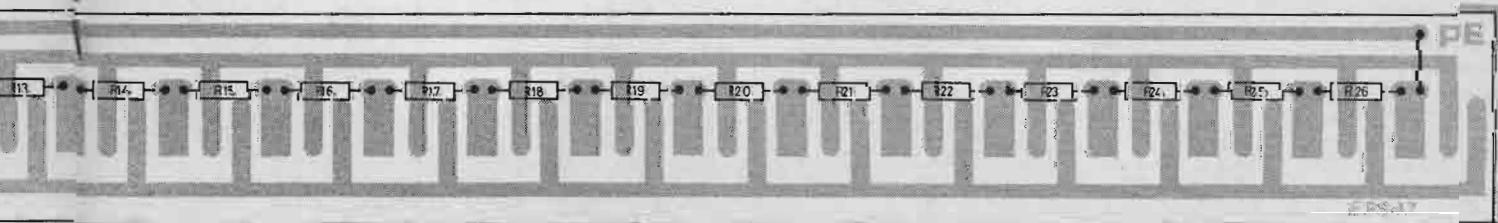

or other, the Sample and Hold will sample VCO2 waveform and the pitch of both VCOs will be modulated apparently at random. Alternatively switch VCO2 to LFO mode, running slowly with a ramp or triangle output. VCO1 will now be modulated by the staircase waveform coming from the Sample and Hold. Next set up the wind effect again and switch the thumbwheel output into the VCF to achieve trendy random or staircase filtering effects (the LFO must be running, with the level control fully up). This also works well with a ramp output from one or both VCOs—listen to a Jean Michel Jarre album sometime!

VCO1 mark/space modulation

Use the triangle output from the LFO to modulate the VCO1 squarewave (remembering to select the square wave output from VCO1). Slow, large amplitude modulation will give a phasing effect while somewhat faster, small amplitude modulation will give a chorus or string ensemble effect. Try switching in the Sub Octaves.

Harpichord

Try the chorus effect with a sharp Attack and longish Release, the "ADSR" switch on, and the VCF switched to band pass. Vary VCF Frequency control for the best result. Try the sub octaves. See what effect the VCF "Keyboard Mod" switch has.

Once the whole instrument has been tested you can really start experimenting! Try anything and everything—the most interesting effects tend to be discovered by accident. Keep a stock of program sheets and record the settings for any effect you wish to keep—there are so many possibilities it is pointless relying on memory.

CASE CONSTRUCTION

Ready built cases and panels will be available from *Clef*, but for those constructors wishing to make their own the dimensions are shown here. It is possible to use a longer keyboard if desired simply by extending the length of the case and the front panel. The end cheek shown in Fig. 14 is the same regardless of the length of keyboard used, while the front, back and keyboard support bars (all of equal length) should be $15\frac{1}{2}$ in for the 25 note keyboard.

The case was assembled by drilling $\frac{1}{4}$ in holes in the end cheeks in the positions shown and screwing 2 in wood screws through these directly into the front and back pieces, but if preferred there is ample room for gluing batons into the corners and screwing into these. Either way the screw heads should be countersunk into the wood of the end cheeks. Having built the basic frame, the bottom panel is cut from $\frac{1}{4}$ in plywood or hardboard and glued and screwed in place, again countersinking. This bottom panel should be cut slightly larger than the framework and then planed off flush with the walls once in place.

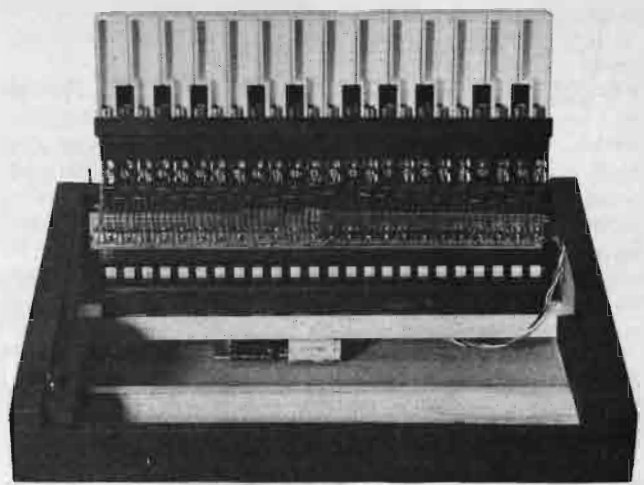

Showing hinged keyboard assembly

Dummy keys are cut from $\frac{1}{4}$ in wood as shown in Fig. 13 and glued inside each end cheek, having first securely araldited the thumbwheel to the left hand end cheek. Remember to solder the wires to the edge pot first, as you won't be able to get at it afterwards. $\frac{3}{8}$ in square x 6 in strips of wood are glued along inside the top edges of the end cheeks to form panel supports, being placed slightly below the tops of the end cheeks to allow for the thickness of the panel. Plane off also the top edge of the back wall at a slight angle to allow for panel thickness, so that when in place the panel will fit flush with the tops of the end cheeks.

A cut out should be made in the back wall of the cabinet and a small piece of 16 s.w.g. aluminium drilled to take the sockets and the mains cable. This should then be sprayed black and labelled and screwed in place behind the cut out, see Fig. 15. The dimensions will depend on the type and number of sockets used: the sequencer terminal should be a 5 pin 180° latching DIN socket; the outputs will normally be $\frac{1}{4}$ in jack sockets, although professional users may prefer cannons, while for purely domestic use through a hi-fi, phono sockets may be best.

Fill the screw holes with wood filler and sand down; the

Fig. 13. (Right) Showing dummy keys

Fig. 14. (Below) End cheek detail of instrument

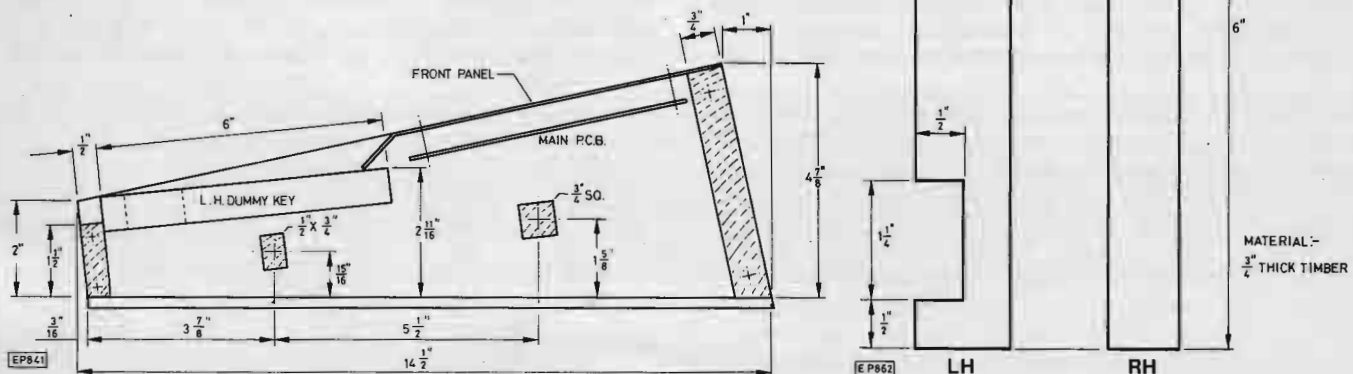

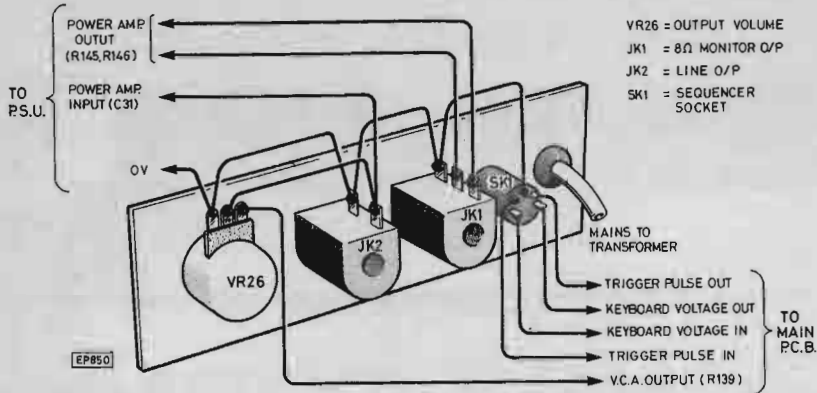

Fig. 15. Rear panel connections

entire case is now covered with black plasticised cabinet cloth (obtainable from Maplin or most electronic/disco shops), using a "Thixofix" type adhesive. Both surfaces must be completely covered with a thin layer of adhesive and allowed to dry, in order to obtain the best finish and avoid peeling.

Screw some rubber feet to the corners and bolt a strap handle through the left hand end cheek if required.

PANEL

The panel is constructed from 16 s.w.g. aluminium as shown in Fig. 16. Having cut all the holes, thoroughly clean the drilled and filed aluminium with "Brillo", then thoroughly dry with tissues taking care not to get any grease back onto the metal, and spray with several thin coats of matt black car paint, allowing a few minutes to dry between each coat. The white lines are put on with $\frac{1}{8}$ in white car stripe (from most car spare shops and garages). The panel is labelled with white "Letraset" or similar, and the labelled panel is finished by spraying with a thin coat of clear matt fixative (from stationers).

FITTING THE KEYBOARD

If the keyboard chassis protrudes beyond the ends of the keys, the excess must be cut off with a hacksaw; then fix the hinge at the back of the keyboard to the rear support in the cabinet using self tapping screws. If the keyboard used does not have a hinge at the back, it is recommended that the rear support be made to pivot in the cabinet by drilling $\frac{1}{2}$ in deep holes in the end cheeks and in the ends of the support bar and inserting 1in metal rods (such as 1in 4BA bolts with the

heads sawn off) into the holes. In any case, position the keyboard carefully so that it will pivot freely between the dummy keys at either side, and so that the keys do not foul the front of the cabinet. Check that the panel fits correctly with a slight gap between the sloping front and the tops of the keys.

The keyboard p.c.b. of Fig. 11 is glued underneath the keyboard chassis, having first mounted the resistors. The gold wire contacts should then be soldered in place so that the longest wire presses against the bottom of the key plungers. The other contacts are then added, and bent so that there is a small gap between each of the wires when the keys are not pressed. Ensure that all three wires under each key meet when that key is depressed, but avoid having too small gaps between them when the keys are not depressed, or else mechanical vibration may cause spurious triggering.

FINAL ASSEMBLY

Having made all the various connections between the three p.c.b.s, the thumbwheel edge pot and the back panel, and after setting up the circuitry, the main p.c.b. bolts beneath the front panel using 2in threaded spacers. The power supply p.c.b. should be bolted to the floor of the cabinet behind the keyboard using $\frac{1}{4}$ in threaded spacers. Assembly is completed by fixing the front panel in place with four self tapping screws and then pushing the knobs over the pot spindles protruding through the panel. ★

Fig. 16. Front panel drilling detail

