

MATRIX SWITCH PATCHING

I. Patching from one module output to the input of another module.

All ARP Series 2000 Synthesizers are equipped with matrix switches along the top and bottom of each cabinet. The matrix switches are used to make electrical interconnections between the Series 1000 function modules in the cabinet. Note that the matrix switches are divided into groups of ten "sliders", each of which can be moved vertically to line up with any of the twenty horizontal lines. The spaces between the two groups of ten horizontal lines are "off" positions. Each of the 20 horizontal lines represents a free or uncommitted buss wire which runs the whole length of the cabinet. Positioning a slider to any horizontal buss makes an electrical connection between the function module input or output associated with the slider and that horizontal line. If any number of sliders on the cabinet are positioned to the same horizontal line, an electrical connection will be made between the function module inputs and outputs associated with those sliders.

EXAMPLE: Positioning the sliders directly below the sawtooth wave output of the 1004-T Oscillator and the Audio "A" input to the 1005 ModAmp makes an electrical connection between these modules. Any horizontal line could be used to make this connection. Any number of additional module input sliders may also be positioned to that same horizontal line and each of these inputs would receive the sawtooth output of the 1004-T oscillator.

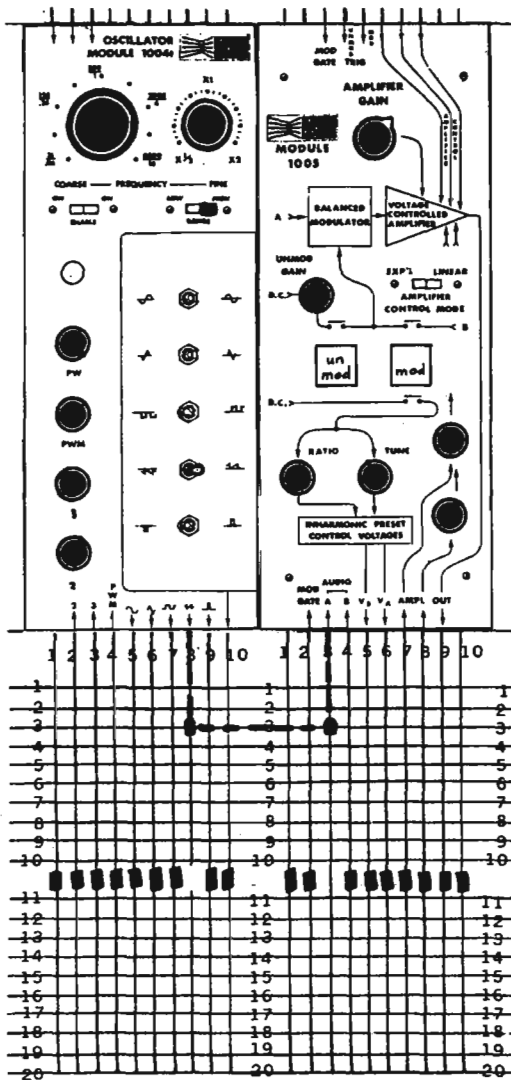

Electrically, connecting an additional input to a horizontal line will not affect the signal on that line. All module inputs have a high impedance—that is, they “sense” the electrical signal which is connected to them without affecting the signal itself. Therefore, any number of inputs can be connected to a single output.

MATRIX SWITCH PATCHING

II. Using the Matrix Switches to Mix Module Outputs

When the outputs of two or more Series 1000 modules are connected to the same horizontal buss, the signals appearing at the module outputs are "averaged" together.

EXAMPLE: If the outputs of four oscillators are connected together on the same line, the four tones will be "mixed" together in equal amounts. This provides a simple way of mixing signals together in equal proportion. Here a four-note chord is produced with all tones equal in intensity.

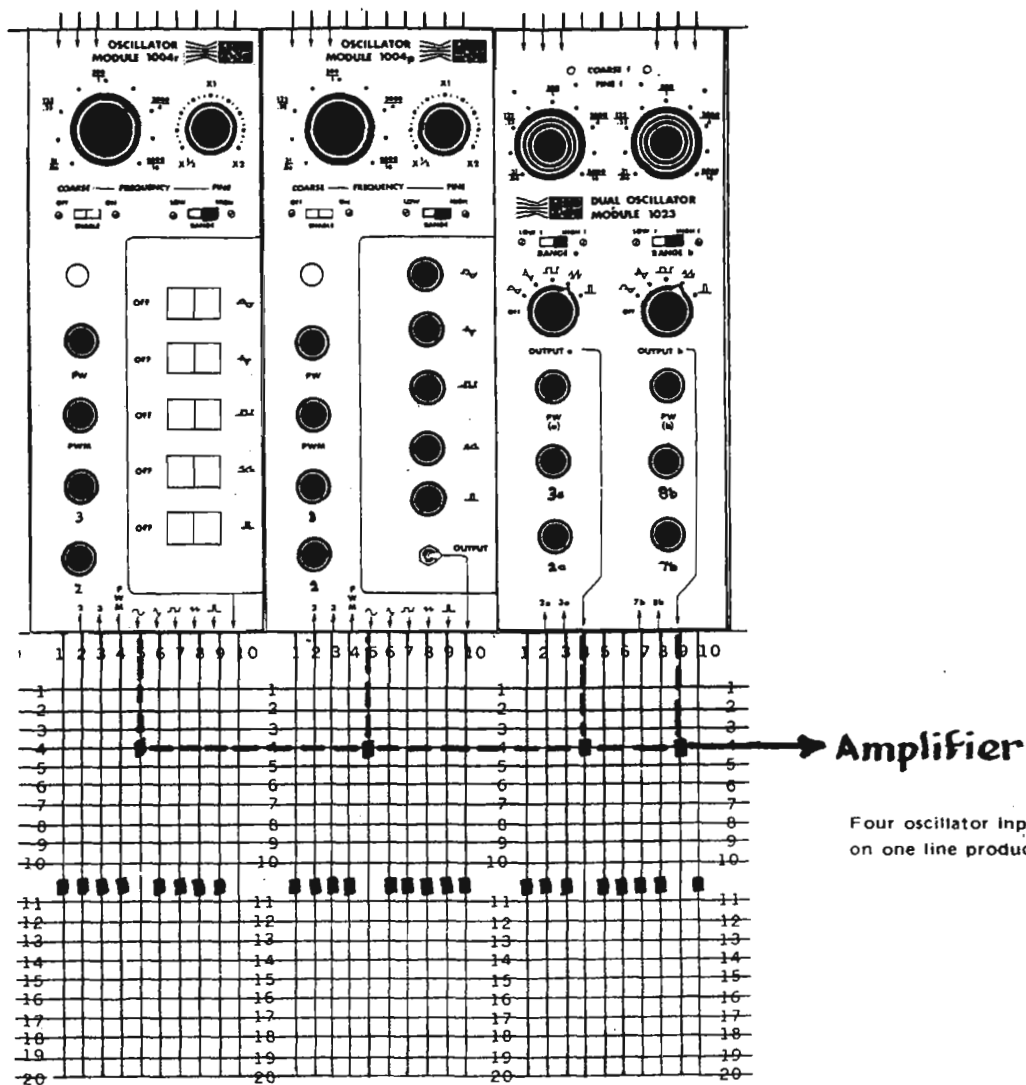

MATRIX SWITCH PATCHING

III. Use of Jack Panels to Route Signals to and From External Equipment.

At each end of the lower matrix switches is a panel with twenty jacks. When a plug is inserted into one of these jacks, an external connection can be made to the matrix switch horizontal buss corresponding to that jack. Normally a convenient horizontal line (like line 20) is used as a final output from the entire synthesizer and the jack at the end of that line is connected by cable to the studio playback system and tape recorders. If it is desired to process external signals through the synthesizer, these signals can be connected to any horizontal lines through the end jack panels, processed through the desired function modules, and then fed back out of the synthesizer on other horizontal lines.

EXAMPLE: The outputs of two tape recorders are fed into the synthesizer through the end jack panels and routed through a 1047 Multi-Mode Filter. The low-pass and high-pass outputs of the 1047 are then returned to the studio monitor system.

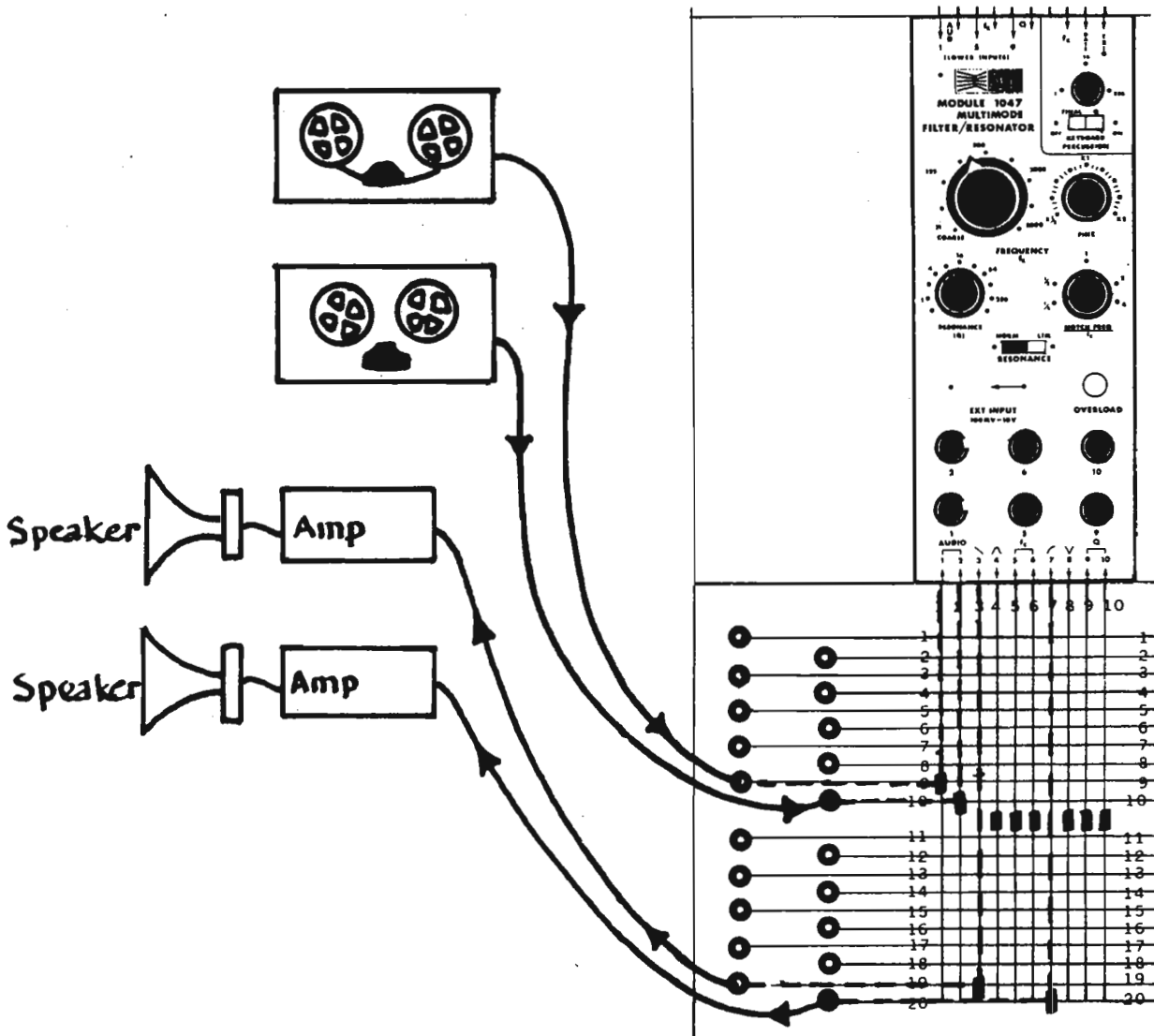

MATRIX SWITCH PATCHING

IV. Use of Upper Matrix Switch Sections

The upper matrix switch sections are identical in function to the lower matrix switch sections except that on ARP Synthesizers which are equipped with keyboards a number of the horizontal lines are committed to use as keyboard outputs. The jack panel in the upper left hand corner of the cabinet shows which keyboard output signals appear on which horizontal lines. Any horizontal lines which are unlabelled or correspond to options not yet added to the system (like a second keyboard) are uncommitted and may be used in the same manner as the lower matrix switches. However, a blank plug inserted into the upper left hand jack panel will disconnect keyboard outputs normally connected to that line. The buss will then be free to handle signals to and from modules.

EXAMPLE: In most instances the upper matrix switches are used to couple keyboard output signals to function modules. Here the keyboard "Out" voltage is applied to a 1004-P oscillator and a 1006 FiltAmp while the "Gate" and "Trigger" outputs are applied to the "Gate" and "Trigger" inputs of a 1003 Dual Envelope Generator.



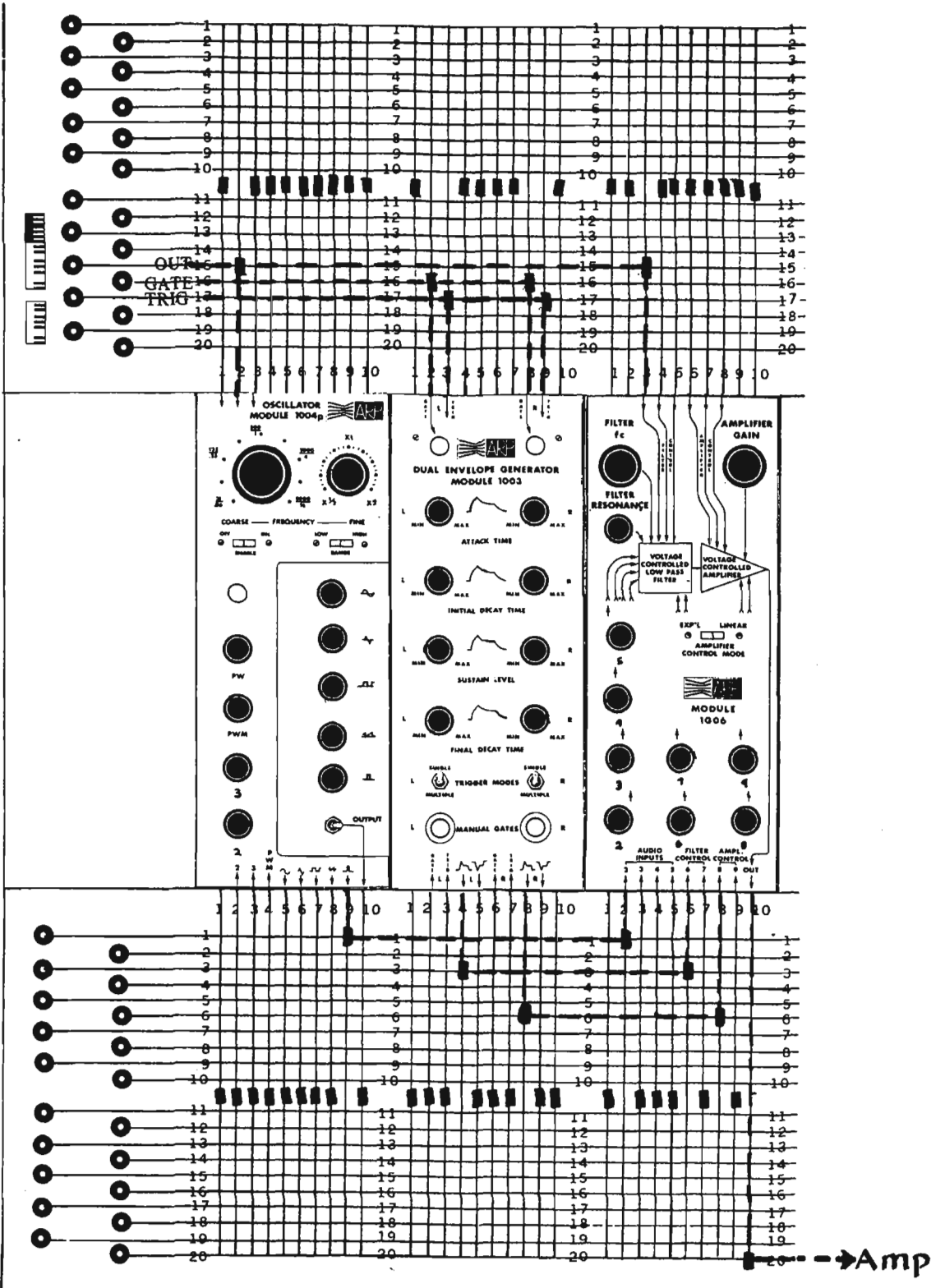

ARP FUNCTION MODULES

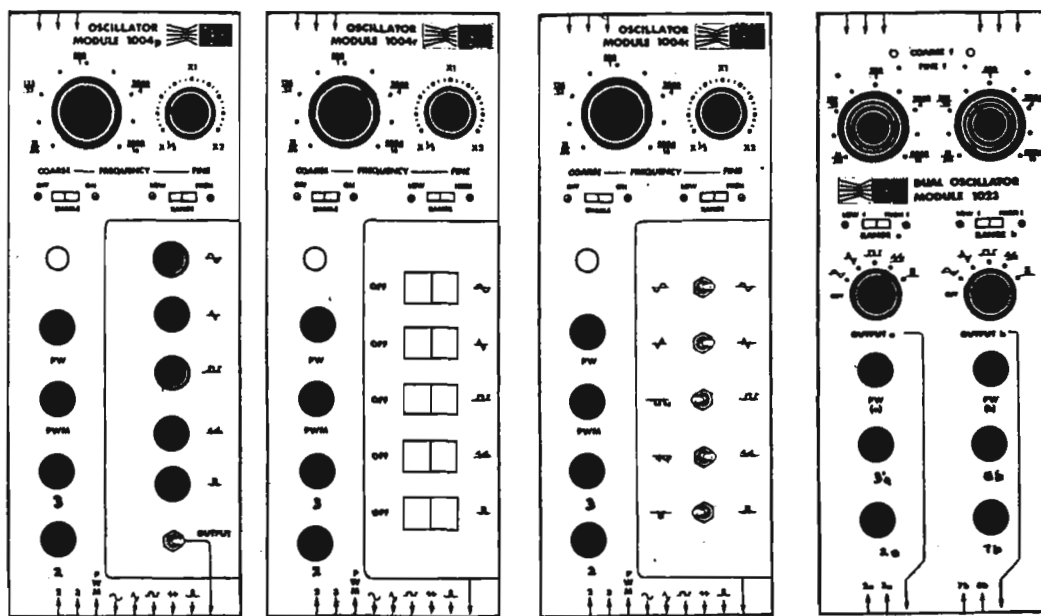

ARP Voltage Controlled Oscillators: 1004-T, -R, -P, and 1023.

All ARP Voltage Controlled Oscillators use the same basic circuit. The different models vary only in the arrangement of inputs and outputs. The Technical Data sheets should be consulted for a detailed description of these differences.

All ARP Voltage Controlled Oscillators offer five basic waveform outputs: sine, triangle, square, sawtooth, and pulse. Each waveform has its own characteristic sound due to the nature of its harmonic content.

EXAMPLE: Any of the 1004 family of oscillators can be used for this example. Line 20 of the lower matrix switch is hooked up to a speaker and amplifier through the jack panel at either end of the cabinet. Move the sliders under each output waveform one at a time to line 20 so that you can familiarize yourself with the characteristic sound of each of these waveforms. While listening to the pulse waveform, turn the knob labelled PW and listen to the changes in timbre. Try several waveforms together. Try varying the frequency of the tone using the "fine" and "coarse" tuning knobs.

see next page for diagram

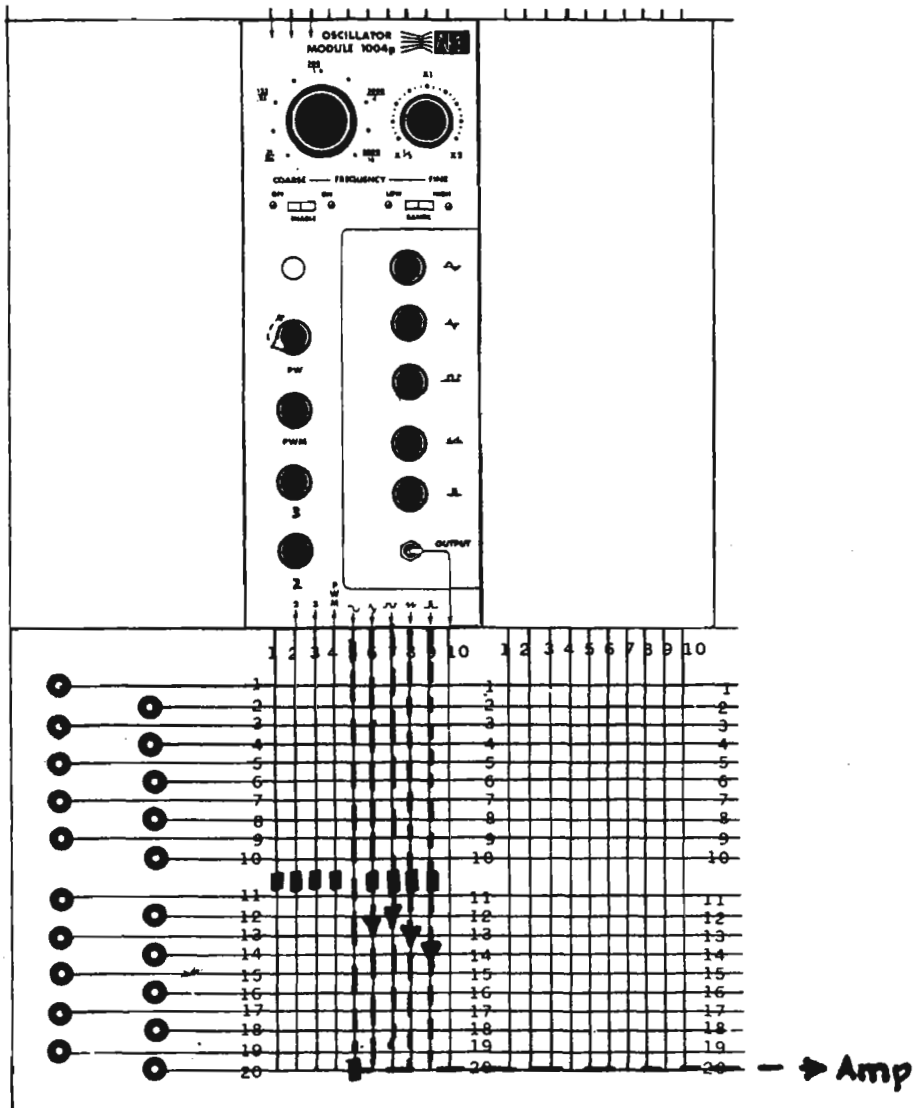

Frequency Modulation

If the pitch (frequency) of an oscillator is turned down very low by sliding the "range" switch on an oscillator to the "low" setting, the low frequency output of this oscillator can be used to introduce a pitch change in another oscillator. Also, the same low frequency signal can be used to change the pulse width of another oscillator. The keyboard can also be hooked up to any oscillator to control its pitch. EXAMPLE: In this example, the pitch of the 1023 oscillator can be varied by the coarse and fine tuning controls, the keyboard, or the voltage coming from the 1004-T oscillator which has been set to a very low frequency. The output of the 1004-T is coupled to both "frequency modulation" inputs to the 1023, labelled "2a and 3a". Advancing either of these controls will increase the effect of the 1004-T output on the pitch of the tone. Try using all possible combinations of waveforms from the 1004-T.

OSCILLATORS

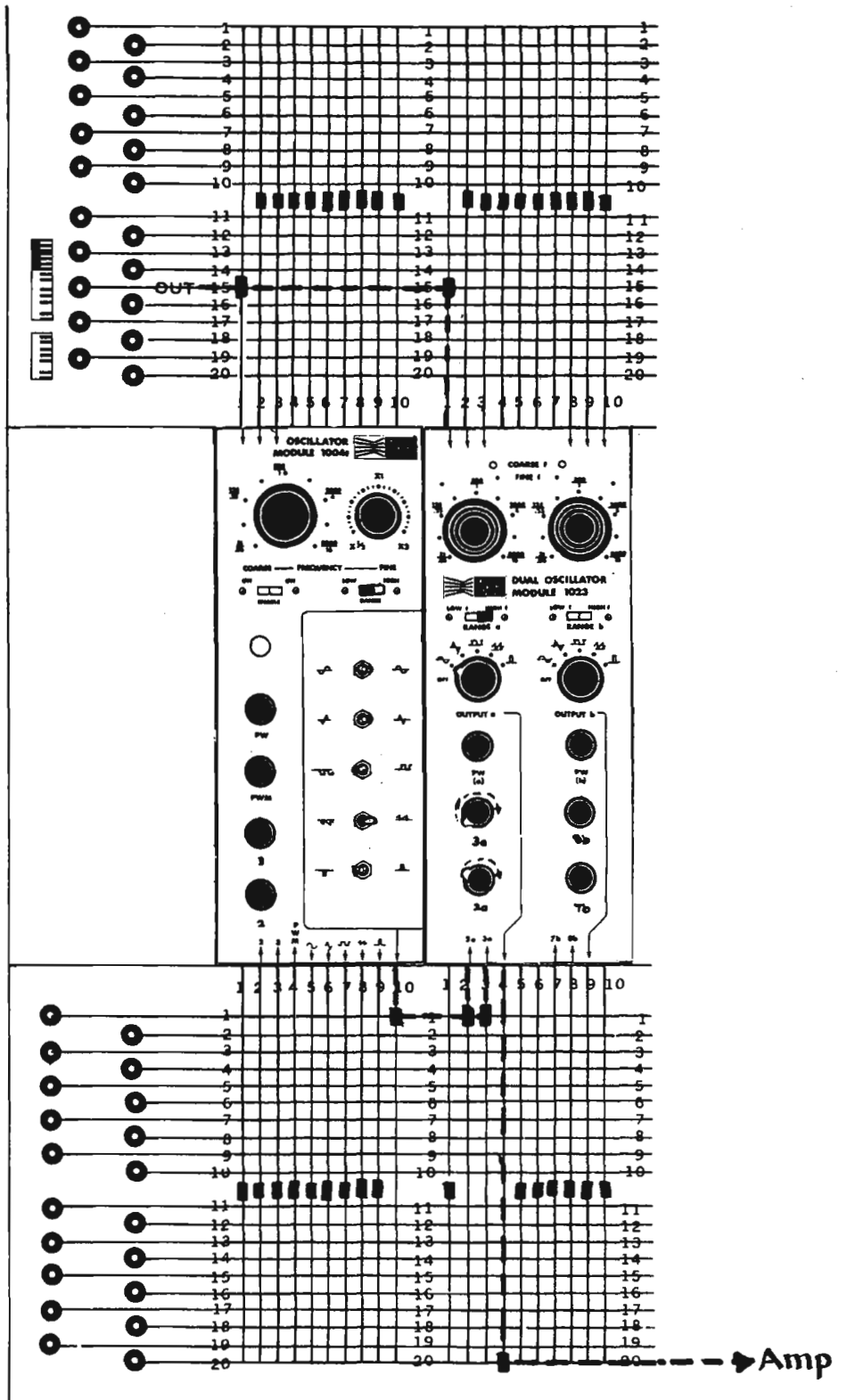

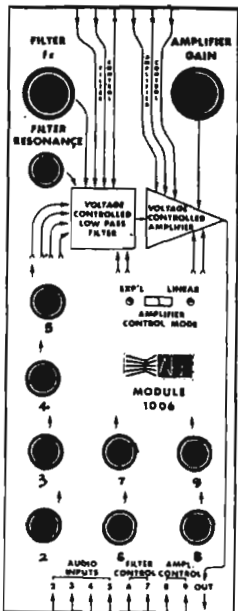

ARP FiltAmp Module 1006

The FiltAmp is a multi-function module which contains a four-input audio mixer, a voltage controlled low-pass filter, and a voltage controlled amplifier. The four-input mixer is used where up to four independent audio signals must be blended in adjustable proportions. The front panel of the 1006 module shows the four "Audio Inputs" from the lower matrix switch positions. There is a front panel control knob associated with each of these four inputs. When one of these control knobs is turned fully counter-clockwise, the audio signal at that input will be turned off, just like the volume control on a radio. When an input attenuator control is turned fully clockwise, the signal at that input is allowed to pass on to the voltage controlled low-pass filter unattenuated. Since the mixing of audio signals within this module is accomplished by adding the four signals together, the user must take care that the "sum" of the input signals after passing through the attenuator controls does not overload the circuit by having the sum exceed the normal 10 volt operating level for the module. For instance, if two 10 volt square waves (normal output of ARP oscillators) are mixed with the input attenuators fully clockwise, the sum of these signals could reach 20 volts—an overload condition. In this case distortion would result and the front panel attenuators for these two inputs should be turned down to roughly 3 o'clock.

EXAMPLE: The outputs of four ARP oscillators (any waveforms can be used) are fed into the four audio inputs of the 1006 FiltAmp. Adjust each input attenuator (the numbers on the attenuators match the numbers over the audio inputs along the bottom) to get different balances between the four tones. Since the mixed signal is passed through the voltage controlled low-pass filter and then through the voltage controlled amplifier, the manual controls for these functions (labelled "Filter f_c " and "Amplifier Gain") should be rotated fully clockwise. The "Filter Resonance" control should be fully counter-clockwise. Be sure that the input attenuators aren't turned up so far that overloading and distortion result. Be sure that input attenuators 7 and 9 are turned down all the way initially.

While listening to only one tone (try a sawtooth wave), turn the " f_c " control back and forth and listen to the changes in timbre. Advance the "resonance" control and repeat. Note that the "Amplifier Gain" control acts like a volume control. By advancing input attenuator 7, the slow sine wave being generated by the 1004-T oscillator will modulate the filter frequency. Advancing input attenuator 9 will introduce amplitude modulation to the signals passing through the FiltAmp. Try different settings of the "Amplifier Gain" knob and the "9" control input attenuator.

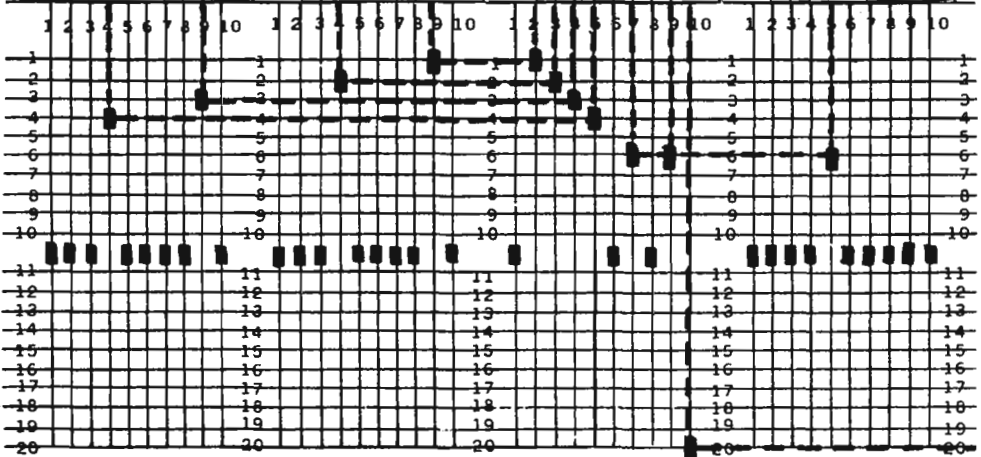
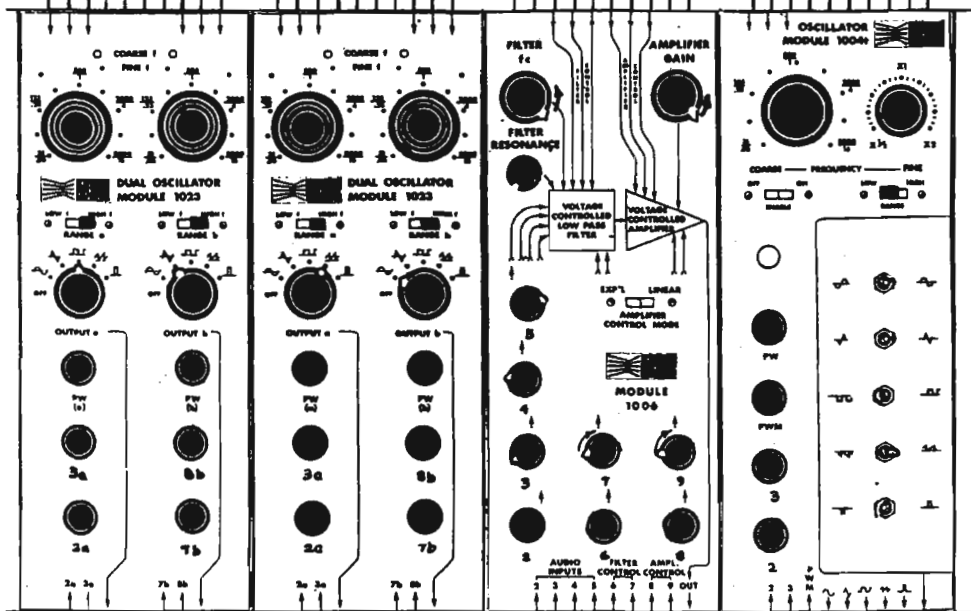
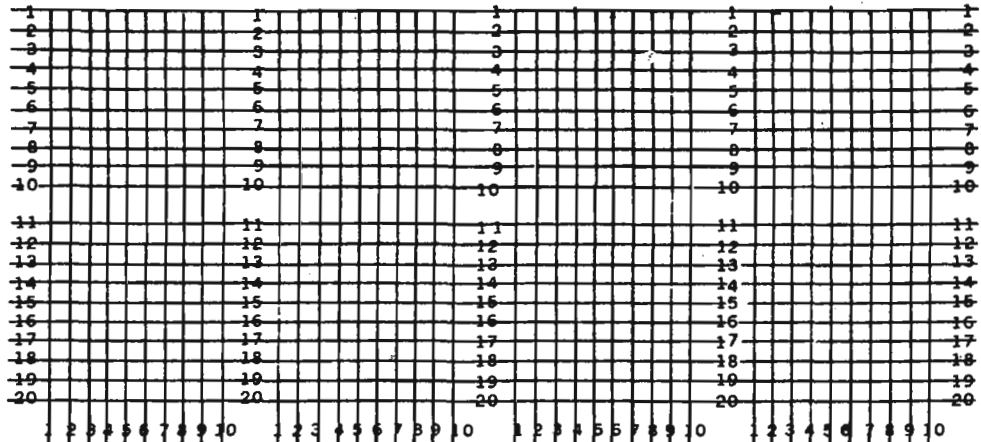

→ Amp

ENVELOPE GENERATORS

1003, 1033 and 1046 Envelope Generators

The 1003 Envelope Generator is identical to the 1033 except that it contains no "Gate Delay" circuits. The 1046 is equivalent in function to a 1003 plus a 1033.

Envelope generators are used to produce repeatable transient control signals. These control signals are most frequently used to control the volume and timbre of a tone with respect to time. For instance, if one were trying to synthesize a sound which resembled a plucked string, it would be necessary to produce an envelope which had a sharp attack and a smooth exponential decay (like the volume of a plucked string). This signal should be applied to the control input of a voltage controlled amplifier so that the volume of the synthesized tone will have the correct shape. Another feature of a plucked string's sound is that the overtones change as the vibrations die out. Initially a plucked string is very rich in harmonics. The harmonics die out quickly, however, resulting in a progressively purer and simpler waveform. The same effect can be achieved by controlling a voltage controlled low pass filter with an envelope generator set for fast attack and slow decay.

The data sheets for the 1003 and 1033 should be consulted for a discussion of the uses of the "Gate" and "Trig" inputs.

EXAMPLE: To synthesize a plucked string sound, two envelope generators are connected to a FiltAmp, one to a filter control input and another to an amplifier control input. The attenuators associated with these inputs are turned fully clockwise. Each envelope generator is set for fastest attack and a moderately long initial decay. The Sustain Level and Final Decay are both set at Minimum. A low pitched sawtooth wave is fed into one of the audio inputs to the FiltAmp and an oscillator frequency control input is connected to the keyboard output. The Gate and Trig inputs to the envelope generators are connected to the Gate and Trig outputs of the keyboard. With the " F_c " and "Amplifier Gain" controls on the FiltAmp set to min, there should be no audible signal. When a note is depressed on the keyboard, the two Gate lamps on the envelope generator should light and a sound should be produced. Whenever a note is depressed, the envelope generators produce output waveforms which open up the filter and amplifier. Try changing the settings of input attenuators 6 and 8, the "resonance" control and the " F_c " control on the FiltAmp. Change the settings on the envelope generator noting that the output of the envelope generators holds at the "Sustain" level as long as any note is depressed. Move both "Trigger Modes" switches from "Multiple" to "Single" and observe that it is now necessary to lift all the fingers off the keyboard in order to get a new attack.

ENVELOPE GENERATORS

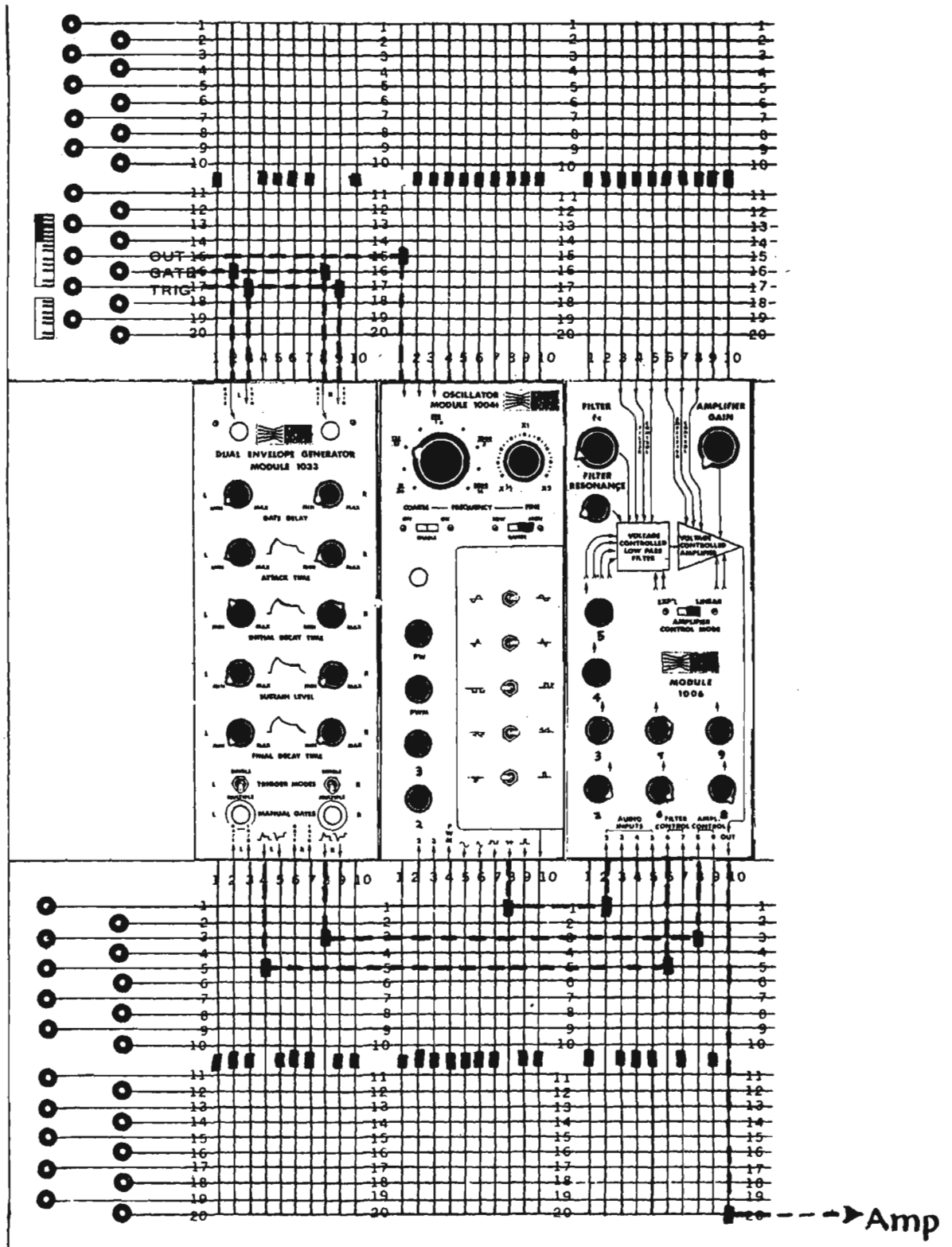

Use of Lower Gate and Trig Inputs

When the "Trigger Modes" switch is set to the "single" position, a Gate signal alone will initiate an attack. In the "Multiple" mode, it is necessary to apply a trigger pulse to the "Trig" input while simultaneously holding a gate signal. Gate and Trig signals can be provided by any fast rising waveform, like the square wave or pulse wave outputs from an oscillator or the outputs of the sequencer.

A "Gate" in traditional electrical terms means any on-off type of signal that defines duration. A "Trigger" is defined as an impulse which has no duration but marks a point in time. Accordingly the Gate and Trigger markings on the ARP Synthesizer refer to these kinds of signals. The keyboard "Gate" output, for instance, goes "on" every time any note is depressed. It stays on until all the notes are released, thereby defining the time that the notes were pressed down. The "Trigger" output produces an impulse of very short duration each time a note is pressed down, regardless of whether other notes are already depressed.

When it is desired to use a square wave as a trigger, as in the following example, the envelope generator internally converts the rising edge of the square wave into an impulse. In this way, the square wave has the same effect on the envelope generator as repeated trigger pulses from the keyboard.

EXAMPLE: In this patch we take advantage of the "multiple" triggering mode of the envelope generator and the lower "Gate" and "Trigger" inputs to get repeated fast attacks producing a mandolin type of sound.

A sawtooth wave from the right side of the 1023 Dual Oscillator is fed through the 1006. Since the "Amplifier Gain" control is set to minimum, the sawtooth wave is fully attenuated. However, when a control signal from the envelope generator appears at input "8", the amplifier gain increases and the sawtooth wave is audible for the duration of the envelope. If the "Attack Time" on the envelope generator is set to minimum, the "Initial Decay" control set fairly short, and all other controls set to minimum, the envelope will resemble the amplitude characteristics of a plucked string.

When the "Trigger Modes" switch on the envelope generator is in the "Multiple" position, it is necessary to have both a Gate and a Trigger pulse in order to initiate an envelope. In this example, the "Gate" signal is provided by the keyboard Gate output and the triggers are provided by the 1004 oscillator's square wave. When no keys are depressed, only triggers are entering the envelope generator. This has no effect without a gate, too. When a note is pressed down and a Gate signal is present, a new attack will be generated each time the 1004 oscillator produces a positive going edge on its square wave output. Try sliding the lower Gate input of the envelope generator to a very slow pulse from the left side of the 1023. Try using the "Manual Gate" push button. Try changing all oscillator frequencies and envelope characteristics.

ENVELOPE GENERATORS

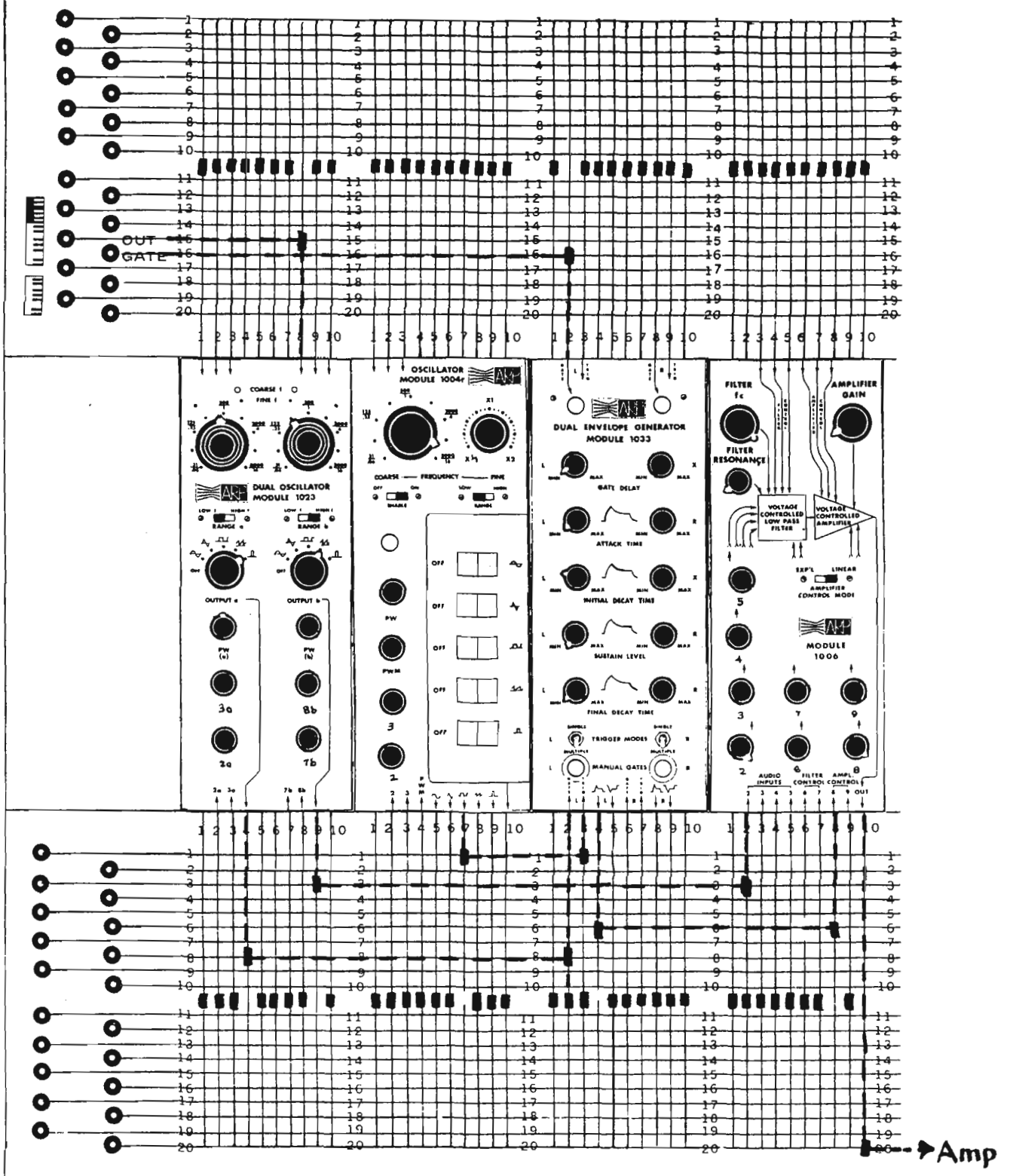

ENVELOPE GENERATORS

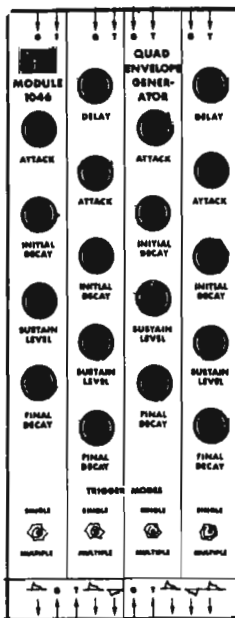
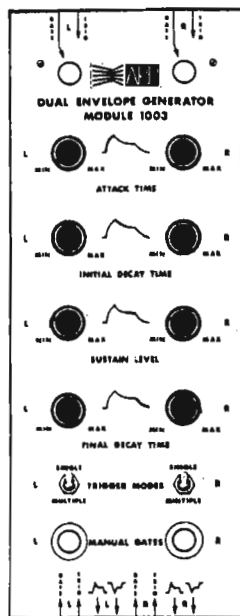
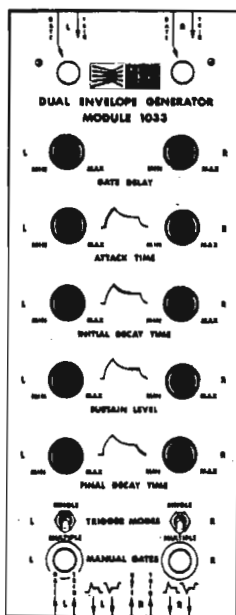

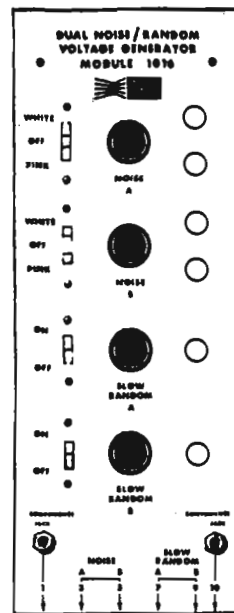

1016 Dual Noise/Random Voltage Generator

The 1016 module provides two separate and uncorrelated white noise sources. Pink noise is obtained from each of these sources by filtering. A slow random voltage is produced by successively filtering and amplifying the white noise.

“White” noise is described technically as having a “flat power bandwidth” across the entire audio spectrum. What this means in terms of its sound, is that there will be an equal amount of acoustic power in any band of frequencies of the same width in cycles per second. For instance, if we were to listen to the band of frequencies between 100 cps and 200 cps, they would appear roughly as loud as the band between 2100 and 2200 cps. Any band of 100 cps width would have the same power. But since the ear discerns frequency on an exponential basis, the effect of white noise is to sound very strong in high frequencies and very weak in low frequencies. In order to make noise “sound” evenly distributed across the audio spectrum, we would want the power to be equal in any tonal interval, not any cps interval.

If there is the same power in a band from 100Hz to 200Hz as there is from 2100Hz to 2200Hz, this means that the noise itself will sound very weak in low frequencies, since the entire octave of frequencies from 100Hz to 200Hz has the same energy as the small 1/20 of an octave between 2100 and 2000 Hz. The octave between 2000Hz and 4000Hz will have about 20 times the energy of the octave between 100Hz and 200Hz.

Pink noise is produced when white noise is filtered in such a way that the low frequencies are boosted and the high frequencies are cut. Pink noise has an “equal energy per octave” characteristic. To the ear, pink noise appears evenly distributed in power over the whole audio range. For this reason, it is generally more useful musically than white noise.

The “slow random” signal is simply noise which has been filtered so greatly that no audible components are left. The frequencies in the “slow random” signal fall between 1Hz and 10Hz. This subaudio signal is useful for introducing continuous random modulation to a pitch, timbre, or rhythm.

NOISE GENERATOR

EXAMPLE: This patch is designed to allow experimentation with a number of different applications of noise. Set the following controls as specified:

- 1016: Noise B, white or pink, max
- 1006: "Filter F_c " max
 - "Amplifier Gain" max
 - Audio Input "3" max
 - "Filter Resonance" min
 - All other controls minimum

This setting permits the noise to pass through the 1006 unaffected. Listen to both White and Pink noise and try the "Noise B" output attenuator on the 1016. Reduce the setting of the " F_c " control and observe the effect of low-pass filtering on pink and white noise. Advance the resonance control and repeat. Note that the "pitch" of the noise can be controlled by the keyboard. With the resonance control fully clockwise, note that the noise takes on qualities of pitch. With the F_c control about midway, turn on "Slow Random B" for maximum output. By advancing Filter Control input "6", the slow random voltage will modulate the filter cutoff frequency. Return input attenuator "6" to minimum. Set "Amplifier Gain" control to minimum and apply an amplitude envelope by advancing input attenuator "8". Now the output of the right envelope generator will control the amplitude of the signal. Turn the F_c control to min and apply the other envelope generator output to the filter by advancing input attenuator "7". Try different envelope generator settings and various settings of the filter and amplifier controls.

Adjust to new settings:

- 1016: Noise B and Slow Random A max
- 1004: Input attenuators "2" and "3" minimum
- 1006: " F_c ", "Amplifier Gain", Input attenuator "2" Maximum.
 - All other controls minimum.

These settings permit the triangle wave to pass through the FiltAmp unmodified. Frequency-modulate the oscillator first with noise by advancing oscillator input attenuator "2" and then with "Slow Random" by advancing input attenuator "3". Try using the envelope generators as in the previous section.

NOISE GENERATOR

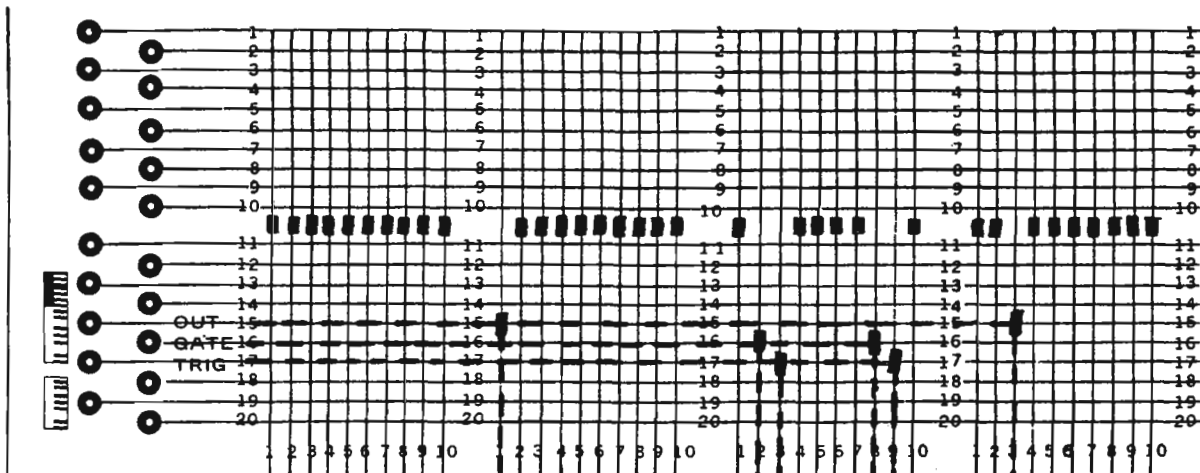

Central control panel for the Noise Generator, featuring four main modules:

- DUAL NOISE / RANDOM VOLTAGE GENERATOR MODULE 1016:** Includes controls for NOISE A, NOISE B, SLOW RANDOM A, and SLOW RANDOM B, with WHITE and PINK frequency filters.
- OSCILLATOR MODULE 1004p:** Includes COARSE FREQUENCY and FINE controls, and PW (Pulse Width) settings.
- DUAL ENVELOPE GENERATOR MODULE 1003:** Includes controls for ATTACK TIME, INITIAL DECAY TIME, SUSTAIN LEVEL, and FINAL DECAY TIME, with SWEEP and TRIGGER MODES.
- FILTER RESONANCE and AMPLIFIER GAIN:** Includes FILTER RESONANCE, VOLTAGE CONTROLLED LOW PASS FILTER, and AMPLIFIER GAIN controls.

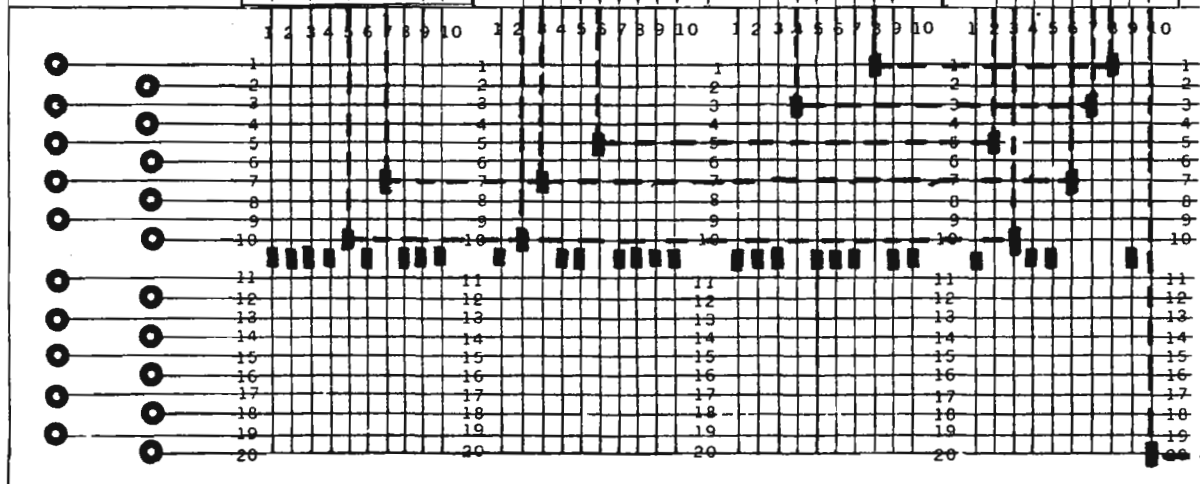

--Amp

MULTI-MODE FILTER/RESONATOR

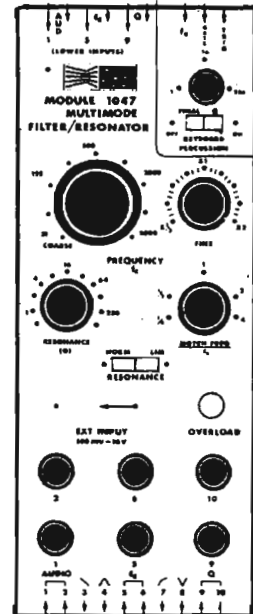

1047 Multimode Filter/Resonator

The 1047 Module is a combination Lowpass, Bandpass, Highpass, and Notch (band reject) filter. There are two audio inputs from the lower matrix switches, each with their own attenuator. All four filter outputs are available simultaneously. The center frequency, f_c , is adjustable from 15Hz to 16KHz by using the front panel f_c "Coarse" and "Fine" controls. " f_c " can be set also by external control signals. The resonance or "Q" of the filter is a voltage controlled parameter and can be set manually or by an external voltage. Note that the center frequency of the notch can be moved 2 octaves either side of f_c .

For a detailed description of characteristics of this filter, the data sheets should be consulted. From a musical standpoint, the filter is very useful in generating new timbres. As the "Q" control is turned up, the filter becomes more resonant. At very high "Q", the filter is so resonant that a pulse applied to the audio input will cause the filter to "ring". This ringing is due to the filter's similarity to mechanical resonators like strings which also "ring" when struck or given an impulse of energy.

Turning on the "Keyboard Percussion" switch automatically connects the "trigger" output of the keyboard to the audio input of the filter and connects the keyboard voltage output to the frequency modulation input to the filter. Thus when a key is depressed, the trigger pulse causes the filter to ring at a frequency which is dependent upon the note that was struck. In this way it is possible to "play" this filter. The "Final Q" control acts like an adjustable damper. When the key is released, the oscillations will die out at a rate set by this control.

EXAMPLE: Set the controls on the following modules:

- 1016: Pink Noise A, maximum
- 1047: Audio "2" max; resonance switch "norm";
"Notch Freq", 1; "Final Q", off.
All other controls minimum.

This setting permits pink noise to pass through the filter. Slide the lowpass output (position "3") down to line 20 and adjust f_c to observe the effect of lowpass filtering. Repeat this procedure for the bandpass, highpass, and notch outputs. Advance the resonance control slightly and repeat this entire exercise. If the overload light comes on, reduce the setting of the audio input attenuator "2".

Advancing f_c input attenuator "6" will modulate the center frequency with a slow sine wave from the 1004-P oscillator. If input attenuator "5" is turned to its maximum setting, the keyboard can be used to control the center frequency. Note that the keyboard is connected to an upper matrix switch f_c input and that this input is labelled "5" indicating that it is connected directly to the lower matrix switch input of the same number. If the "Q" is turned up and one listens to the bandpass output, the noise takes on a very definite controllable pitch.

Listening to the bandpass output, set to "Q" to about 4 and slowly advance "Q" input attenuator to "10". The external sine wave should cause the Q of the filter to vary. When input attenuator "9" is advanced, the keyboard can be used to control Q. Note that the keyboard is connected to an upper matrix switch Q input labelled "9", indicating that this input is directly coupled internally to lower matrix switch input "9" and hence to input attenuator "9".

Reset all controls to minimum. Advancing input attenuator "1" will apply the pulse wave output of the 1004-R oscillator to the filter input. With the 1004-R set to a fairly low tone, listen to the four filter outputs individually while adjusting f_c . Listen to the bandpass output and slowly advance the "Q" control. Note that the filter becomes more selective at higher "Q", and it is possible to tune the filter to each of the harmonics of the pulse wave. The "PW" control on the oscillator should be turned to minimum for this experiment.

Set the "Q" at about 8 and advance input attenuator "5" to maximum. Tune the filter to any harmonic of the pulse wave; the filter should stay locked on that harmonic as the note is changed, since the keyboard is controlling both the oscillator and the filter equally.

Try using the slow sine wave from the 1004-P to modulate f_c and Q, as with the noise experiments above. Tune the filter to any harmonic of the pulse wave. Note that changing the Q of the filter affects only the amplitude of the tuned harmonic. It is possible, therefore, by modulating the Q of the filter, to achieve some intriguing timbres.

Remove the pulse wave by turning input attenuator "1" to minimum. Turn on the "Keyboard Percussion" switch. With the Q set fairly high, listen to the bandpass output. Each time a note is struck, the filter should "ring" at that frequency. Try adjusting the "Q" and "Final Q" controls.

MULTI-MODE FILTER/RESONATOR

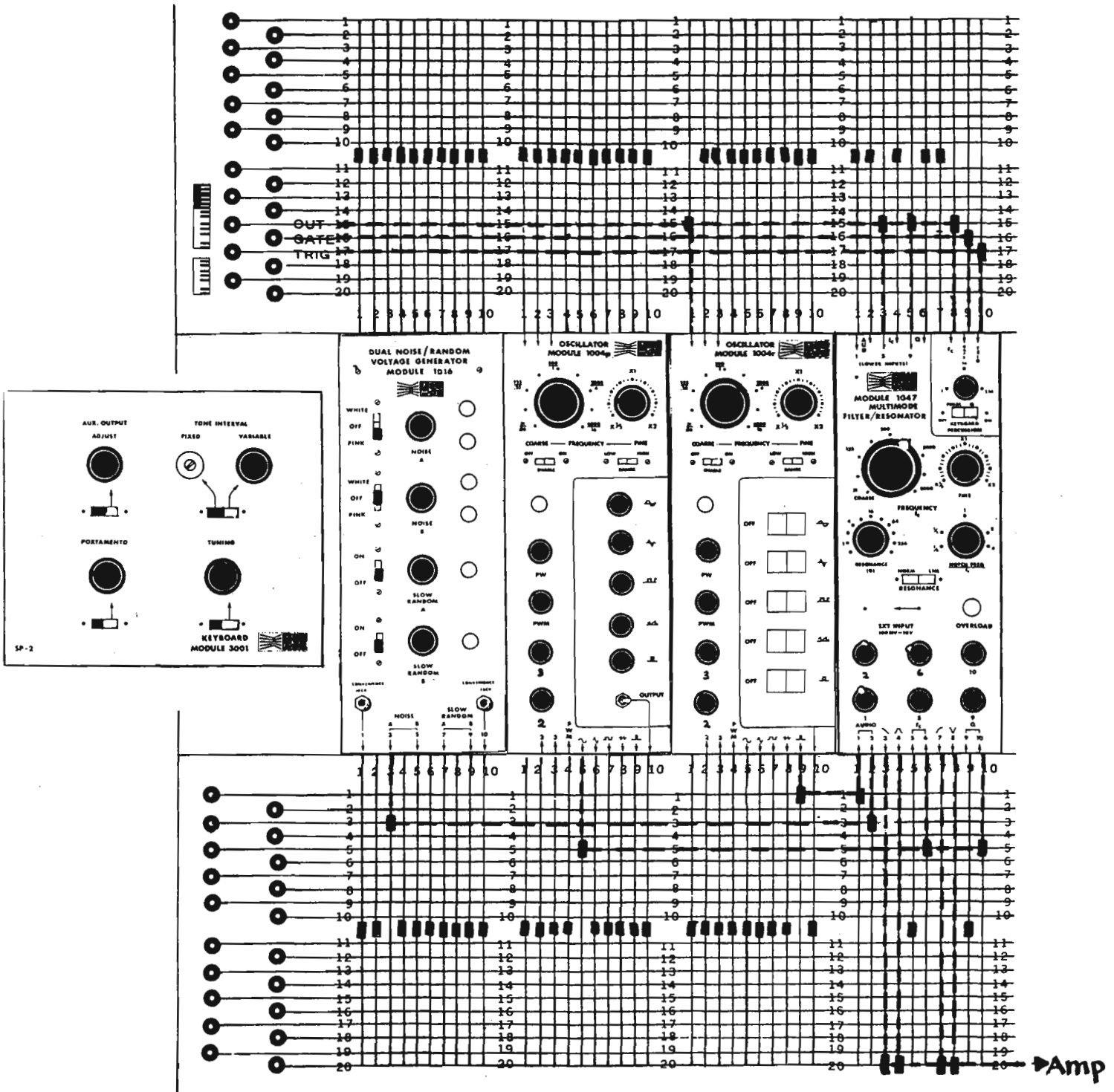

BALANCED MODULATOR

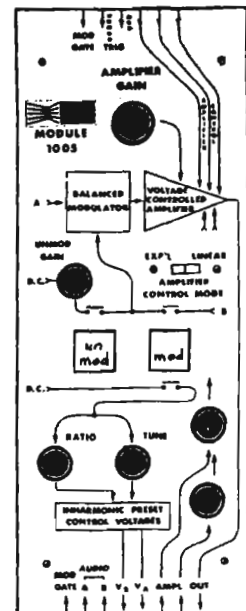

1005 ModAmp

Although the ModAmp contains several functions, its primary use is as a “balanced modulator”. A balanced modulator is simply an electronic multiplier with two inputs, A and B, and an output. The voltage appearing at the output at any time will be equal to the product of the voltages at inputs A and B. (Actually the output voltage is equal to $A \times B/10$, so that the output will not overload when the product of A and B is greater than ± 10 Volts.)

Acoustically, the process of multiplication (or balanced modulation) produces interesting and valuable musical effects. If two sine waves of equal amplitude and of frequencies A and B are applied to inputs A and B of a balanced modulator, the output will contain two sine waves of frequencies $(A + B)$ and $(A - B)$. The original two sine waves are lost in the modulation process. When more complex waveforms are used as signals A and B, the resultant modulated signal will contain not only the sum and difference frequencies of the A and B fundamentals, but also the sum and difference frequencies of all the harmonics. For instance, a sawtooth wave of frequency A contains harmonics of frequencies $2A$, $3A$, and so on. When modulated by another sawtooth wave of frequency B with harmonics $2B$, $3B$, . . . , the output will contain an enormous set of frequencies: $(A + B)$, $(A - B)$, $(A + 2B)$, $(A - 2B)$, . . . $(2A + B)$, $(2A - B)$, $(2A + 2B)$, $(2A - 2B)$, . . . , and so forth. One can easily see that by modulating two sawtooth waves together we create a wide range of new frequencies which may have no harmonic relationship to either frequency A or B. These new frequencies are inharmonic overtones. By choosing frequencies A and B carefully, inharmonic overtones of widely varied colors can be produced.

In the 1005 ModAmp, the two inputs to the modulator are shown as "Audio" inputs "A" and "B". The output of the modulator is fed into a voltage controlled amplifier which is identical to the one in the 1006 FiltAmp, discussed in previous chapters. The modulator may be bypassed entirely, however, by pressing the "unmod" button on the front panel. In this case, the Audio Input "A" is passed directly through to the Voltage Controlled Amplifier. Input "B" is ignored. Pressing the "mod" button will reintroduce the modulator.

Since the process of balanced modulation often obscures the original signals, an undesirable apparent key change can result when two tones are modulated by one another. In order to allow quick switching from "unmod" to "mod" functions without a disturbing key change, "Inharmonic Preset Control Voltages" are provided on this module. This pair of control voltages can be fed back to the two oscillators used to generate frequencies A and B and "detune" them a preset amount when the Mod-Amp is switched from its "unmod" to "mod" function. The preset detuning of the oscillators permits control over any apparent key change which could result from the modulation of the two signals, A and B.

EXAMPLE: In this patch, the outputs of the two oscillators may be modulated together. At first, turn all controls counter-clockwise on the ModAmp except the "Amplifier Gain" control. On the 1023 module, choose two sine waves between 250Hz and 500Hz and listen to the sum and difference frequencies when these two tones are modulated together. Note that when the two frequencies approach unison, the difference tone goes to 0Hz and the sum becomes one octave higher than either of the two input tones.

Advance FM controls 2a and 7b on the oscillator and adjust the "inharmonic preset" voltages to give a controllable change in timbre and pitch when the "mod" button is pressed. Try modulating sawtooth waves and pulse waves.

Note that a "Gate" signal applied to the "Mod Gate" input will cause the operating mode to switch temporarily to "mod" from "unmod". Depressing a black key from the lower 2 octaves will create a gate signal which will cause this transition. The outputs of oscillators, sequencers, and other modules may also be used to activate the "Mod Gate".

With the keyboard "output" controlling the two oscillators, apply an envelope to the sound by turning down the "Amplifier Gain" control and advancing the amplifier input attenuator associated with the input which is connected to the envelope generator.

BALANCED MODULATOR

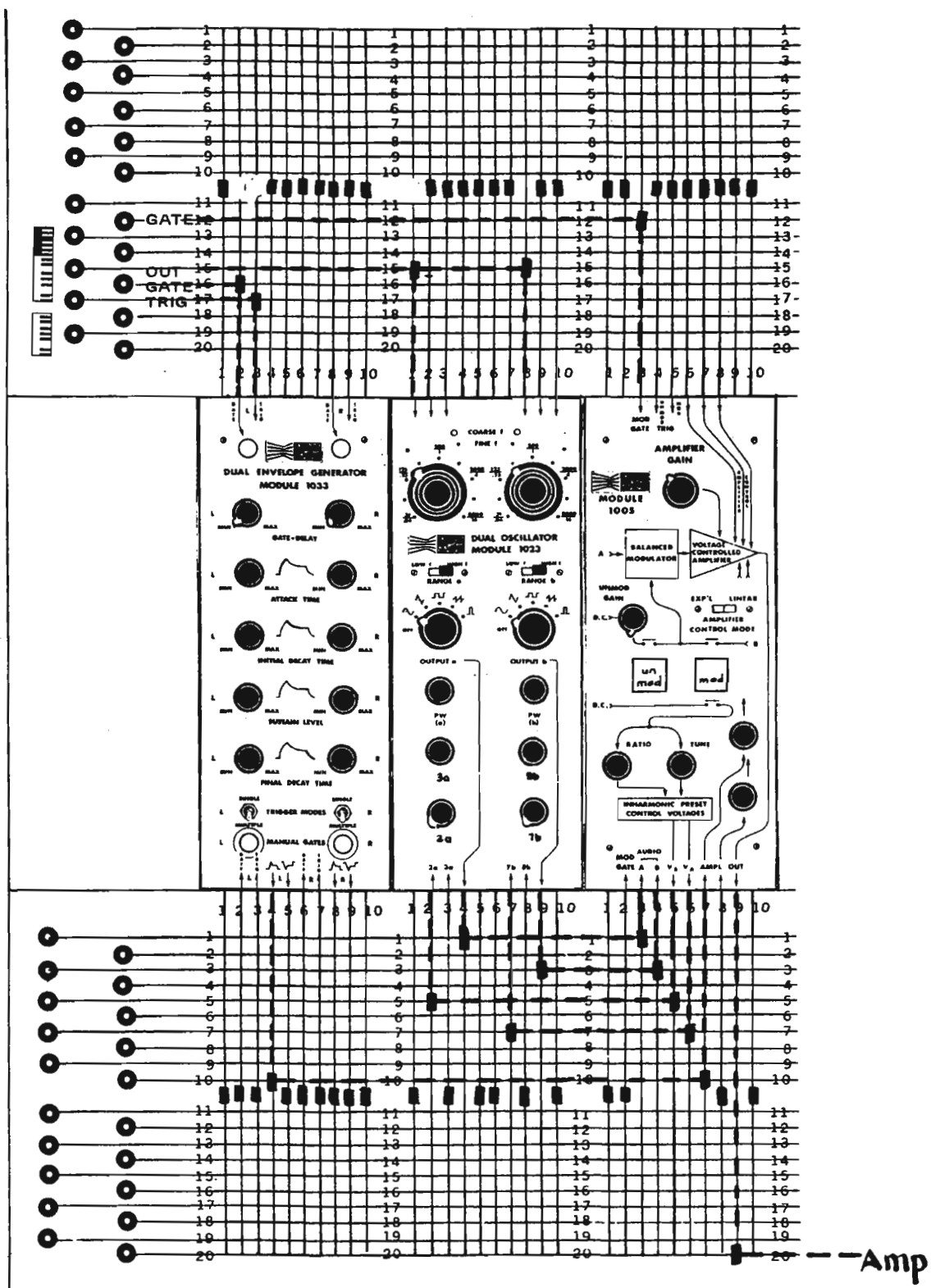

BALANCED MODULATOR

EXAMPLE: In this patch, the ModAmp is switched from "mod" to "unmod" by applying triggers to the "mod" and "unmod" inputs. When a note on the white section of the keyboard is depressed, the ModAmp switches to the "mod" operating mode. When a black note is struck, the ModAmp switches to "unmod". The point of this patch is to demonstrate how the same group of modules can produce very different preset timbres upon simple command.

An interesting tuning for this patch could be as follows: the first pair of oscillators are tuned an octave apart and at a fairly low frequency. The remaining two oscillators are tuned to the fifth in between the octaves and the third above the upper octave. When the octaves are modulated by the fifth and the third, all the sum and difference frequencies fall on the major triad of the octaves, producing an enormous chord. Set the envelope generator connected to the white keyboard section so that attacks and decays are very slow. Using the envelope generator to control the filter will vary the number of harmonics passed through the filter and thereby produce an exaggerated dynamic effect.

When a black note is struck, the ModAmp switches to "unmod" and passes only the two octave tones. A sharp attack on the envelope generator connected to the black keyboard will cause notes played on the black keyboard to contrast sharply with those played on the white keys. Note that the two keyboards will transpose one another up and down in frequency.

BALANCED MODULATOR

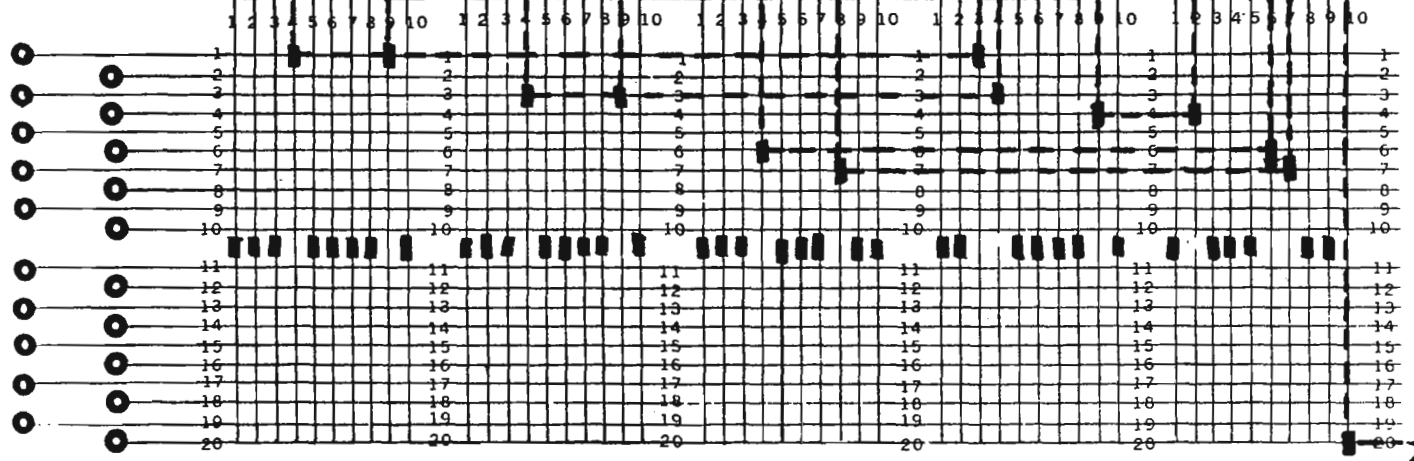
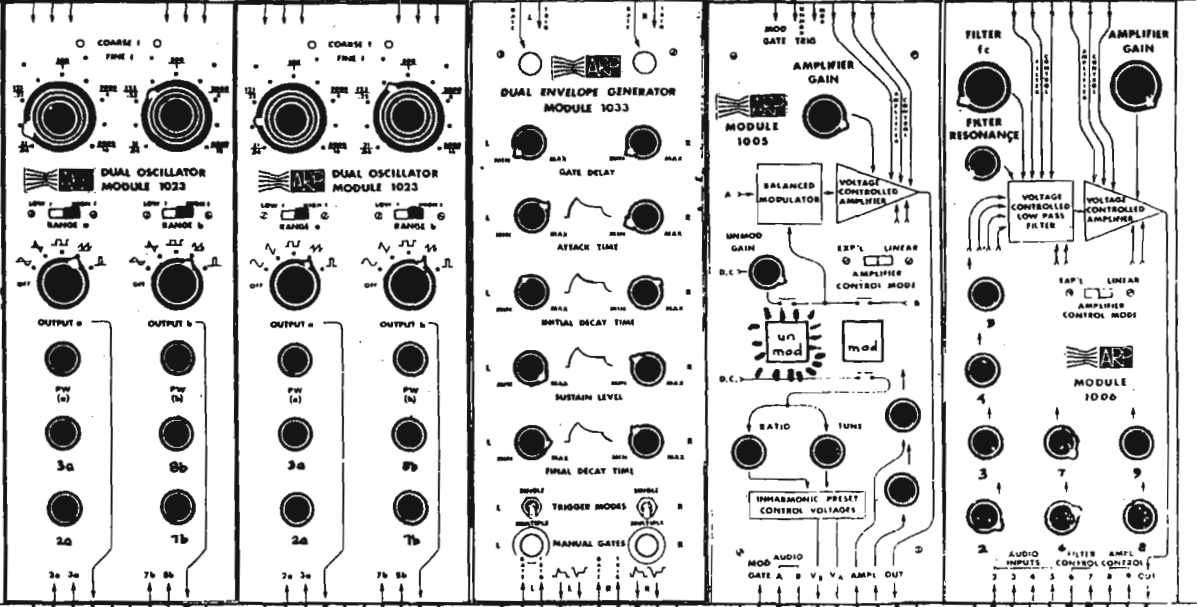
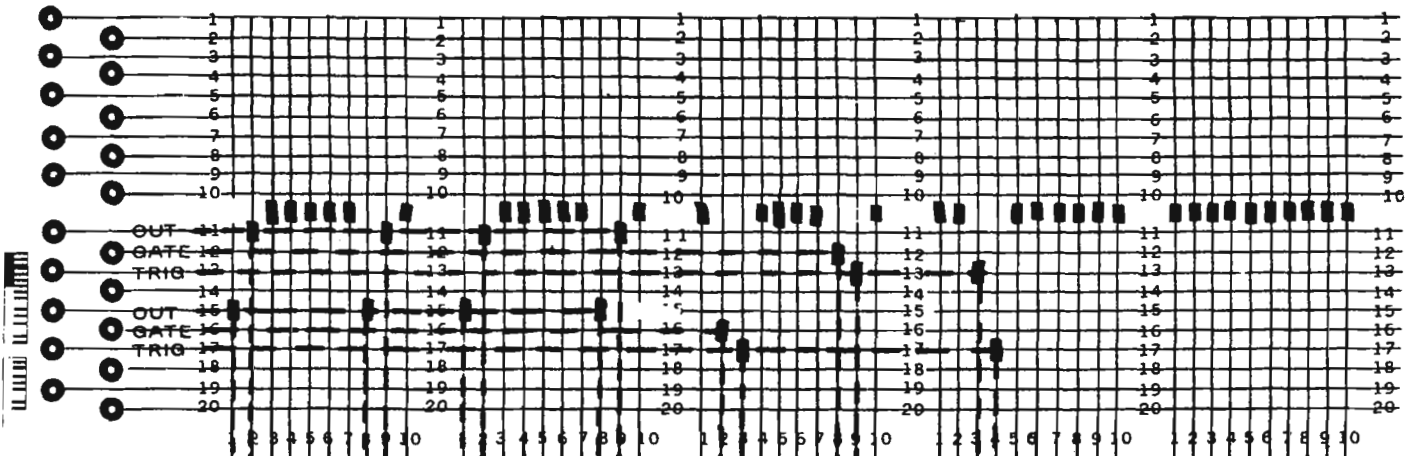

SEQUENCER

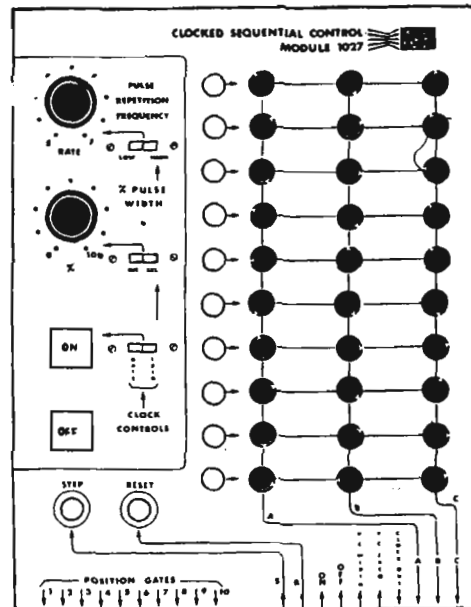

1027 Sequencer

The sequencer contains a ten-step counter which can be used to program up to ten separate events. The "count" of the sequencer is displayed by ten panel lamps. Pushing the "Reset" button will always return the count to the first position. The count may be advanced one step at a time by pushing the "Step" button or it may be advanced automatically by using the internal clock.

Next to each of the ten panel lamps is a set of three potentiometers. Each potentiometer is associated with three voltage outputs: A, B, and C. For each step of the sequencer, the three potentiometers associated with each step will control the three outputs. Therefore thirty voltages may be preset and recalled in ten groups of three. For instance, outputs A, B, and C could be used to control the frequencies of three oscillators and ten chords could be preset.

The internal clock is electrically similar to a 1004 oscillator except that only the pulse waveform is used. The "clock out" output will be a pulse wave whose width can be controlled either by the front panel "% pulse width" control or by using an external signal for pulse width modulation. A red panel light indicates the relative width of the pulse generated by the clock. The "clock out" is used as a gate signal to drive envelope generators and other sequencers.

The ten "Position Gates" are used to get a separate gate signal for each step of the counter.

EXAMPLE: In this example, three-note chords can be preset and then repeated in sequence. An envelope generator and voltage controlled amplifier are used to apply an amplitude envelope to the chord with each new step of the sequencer.

Outputs A, B, and C of the sequencer are patched to the frequency modulation inputs of the three oscillators. Since the range of voltage at these outputs is 0 to +10 volts, the input attenuators on the oscillators are turned down somewhat since a ten octave control range is usually more than is needed. Excessive range causes tuning the oscillators from the sequencer to be more delicate than necessary.

The outputs of the three oscillators are mixed on line 7 and fed into the FiltAmp. The filter part of this module is left wide open and the voltage controlled amplifier is patched to the envelope generators. By turning up the "Amplifier Gain" control, the three note chord should come through steadily, thereby permitting tuning of each chord. When the internal clock on the sequencer is switched "on", the envelope generators will control the VCA and the "Amplifier Gain" control should be turned down.

Note that the sequencer is counting only to 8 before recycling. Shortening this cycle from its usual count of 10 is accomplished by connecting the 9th "Position Gate" to the Reset Input (called "R"). Thus, when the sequencer reaches the ninth step it instantaneously resets to the first position. Remove "Position Gate" 9 and connect the "R" input to other position gates. Note also that connecting a position gate to the "S" input will cause the sequencer to "skip" that position.

The left hand section of the 1033 envelope generator is triggered from the "clock out" signal from the sequencer. Note that the Gate indicator light on the envelope generator flashes in coincidence with the Clock light on the sequencer. The output of this envelope generator is patched to the voltage controlled amplifier. Varying the pulse width control on the sequencer will change the duration of the envelope.

The second envelope generator produces an output only when the sequencer is in its first count position. Note that while the envelope generator is receiving trigger pulses from the "clock out" output with each step of the sequencer, it receives a "Gate" signal from "Position Gate 1" which is active only while the sequencer is in the first position. The output of this envelope generator is also fed to the VCA and reinforces the sound volume only on the first beat of each cycle. Sliding additional "Position Gate" outputs to line 12 will cause accents on these beats also.

SEQUENCER

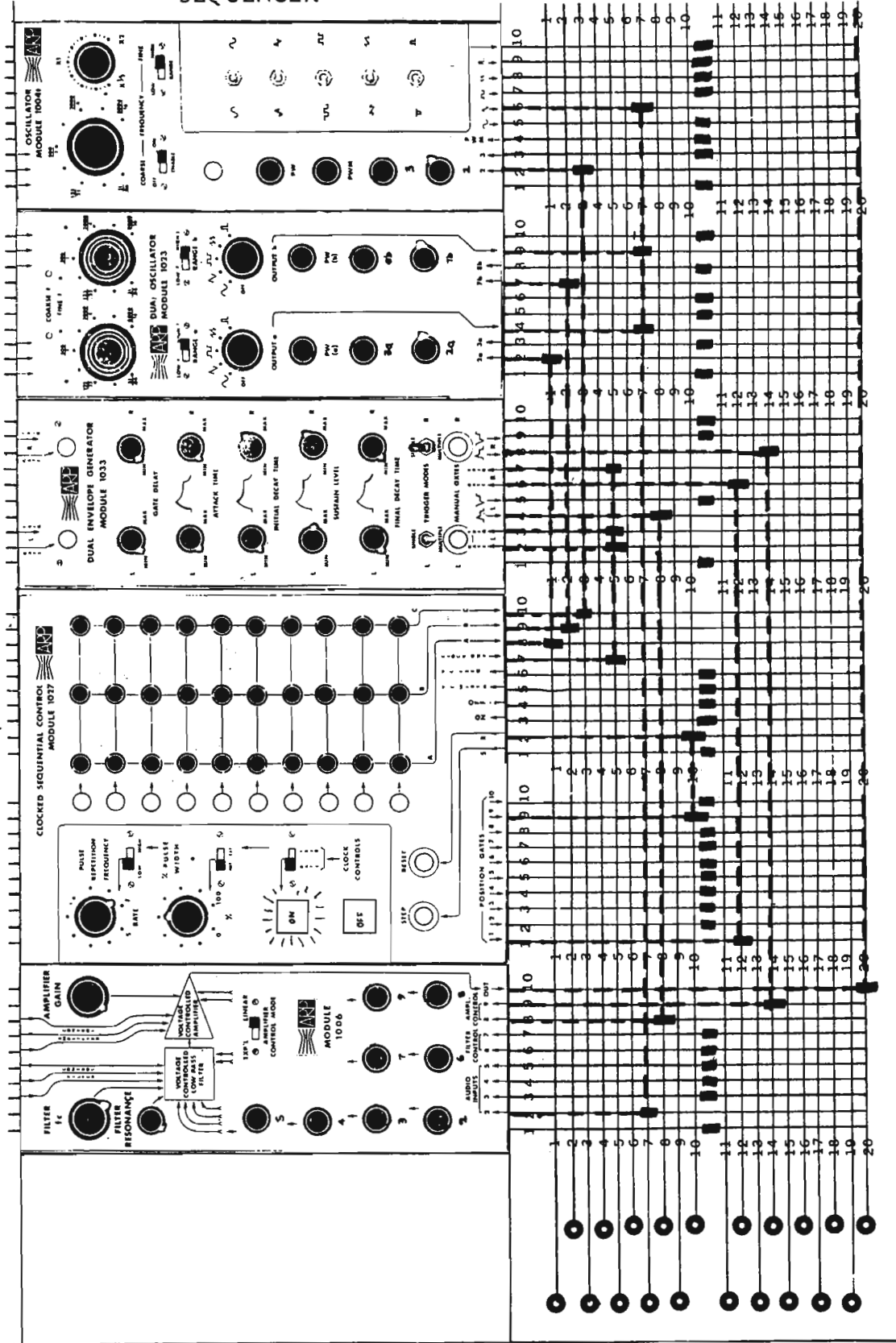

EXAMPLE: By using the “VC Width” input to the sequencer, one of the three columns of controls on the sequencer can be used to preset the envelope length of each of the 10 individual notes produced during one cycle of the sequencer counter. Similarly, by coupling the “VC Freq” input to another column output, the length of time that the sequencer stays in any one position can be adjusted.

Start with all the controls in columns A, B, and C set to minimum. Set the sequencer clock to about one step per second and adjust the 1004-T oscillator frequency for a low pitched tone. Using the controls in column A, set up a series of pitches for the sequence. The “% Pulse Width” switch should be in the “int” position for this part of the example. Note that varying the “% Pulse Width” control changes the length of the envelope.

When the “% Pulse Width” switch is returned to the “Ext” position, the envelope length for each step will be determined by the controls in column B.

By advancing controls in column C, the sequencer can be made to step more quickly through selected positions, thereby creating an adjustable rhythm pattern.

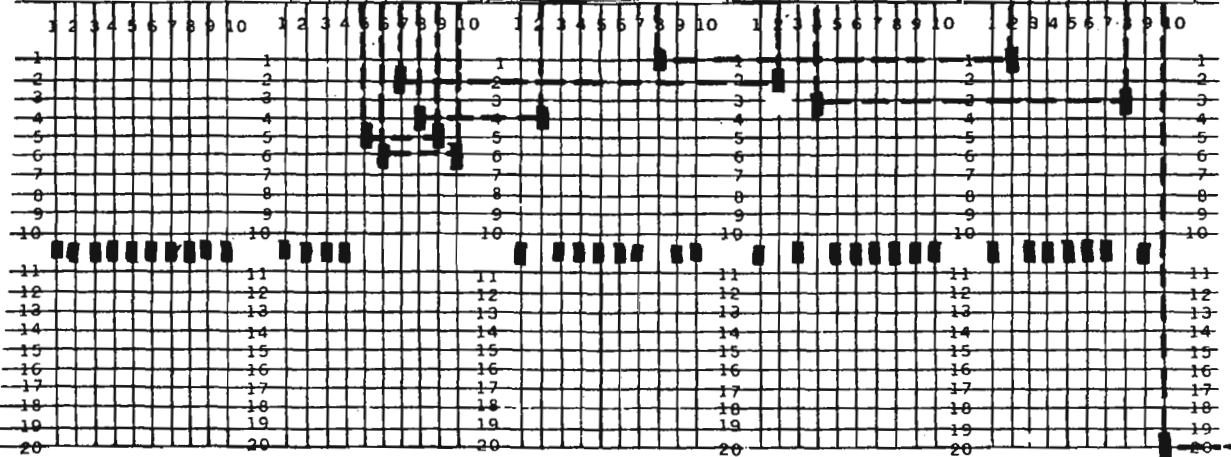
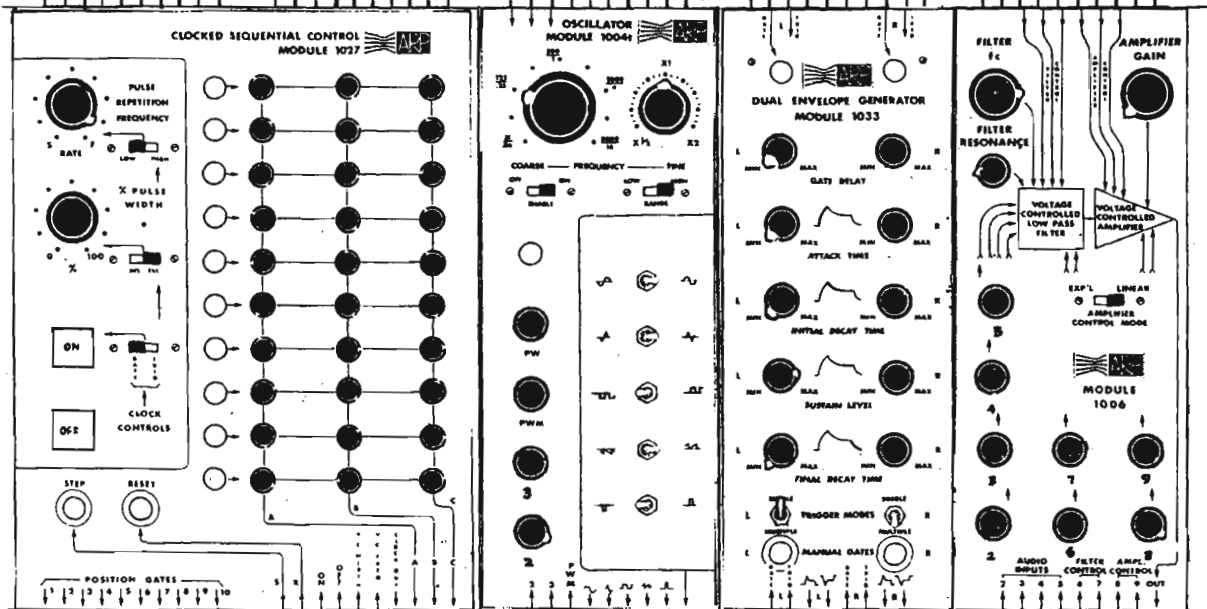
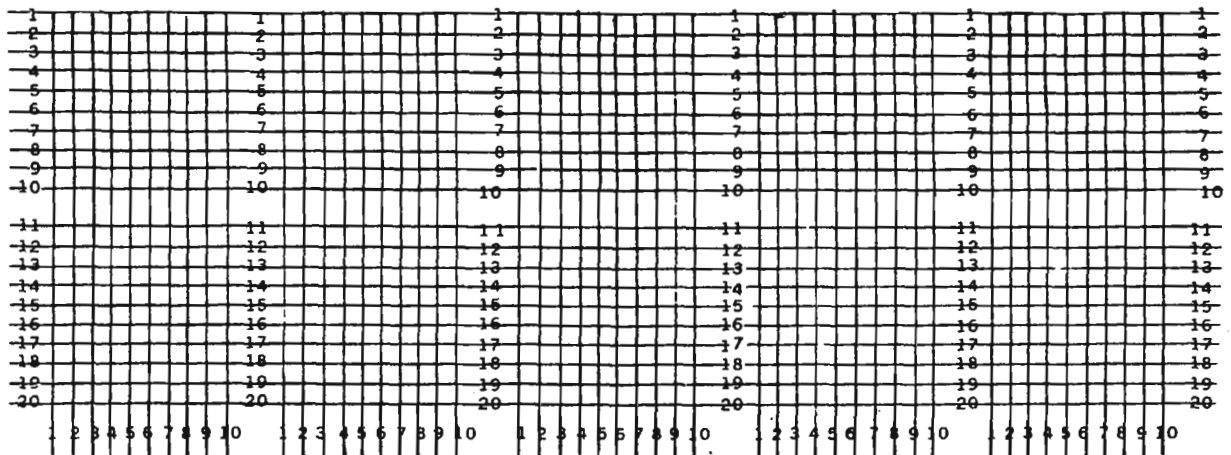

MIX-SEQUENCER

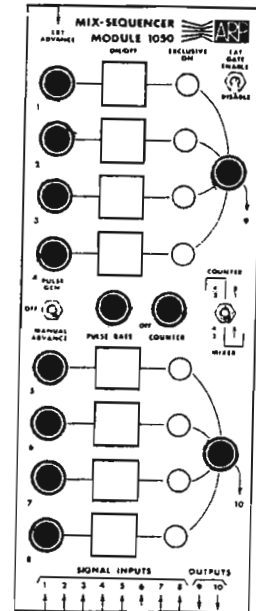

1050 Mix/Sequencer

The 1050 module can be used either as an 8-input mixer with two master gain controls, two 4-input mixers with separate outputs, or as a sequentially controlled analog gate. The mixer has no low-frequency limit and can therefore be used to switch control voltages as well as audio signals. Illuminated push buttons are provided for switching inputs on and off. A column of "exclusive on" push buttons are used for quick selection of single inputs—one input is turned on while all others are turned off.

The "Counter/Mixer" switch determines the operating mode of the 1050. In the center and right hand positions, the 1050 serves as a single 8-input mixer. In the left hand position, the 1050 becomes two separate four input mixers. When the counter is used, inputs are turned on sequentially, one at a time. If the "Counter/Mixer" switch is in the center or left hand positions, the counter is split so that inputs can be activated in pairs, i.e., (1,5), (2,6), . . . The counter may be advanced by using the "Manual Advance" switch, applying an external pulse to the "Ext Advance" input, or by switching in the internal clock.

EXAMPLE: In this example, the 1050 is used as a single 8-input mixer. The frequencies of the five oscillators can be set to any intervals. The outputs of these oscillators can then be mixed or selected one at a time or in groups. By switching off all inputs and turning the "Counter" switch to position 6, the counter will turn on each input sequentially. Try using the manual advance and the internal pulse generator. Note that either output 9 or 10 can be used.

MIX-SEQUENCER

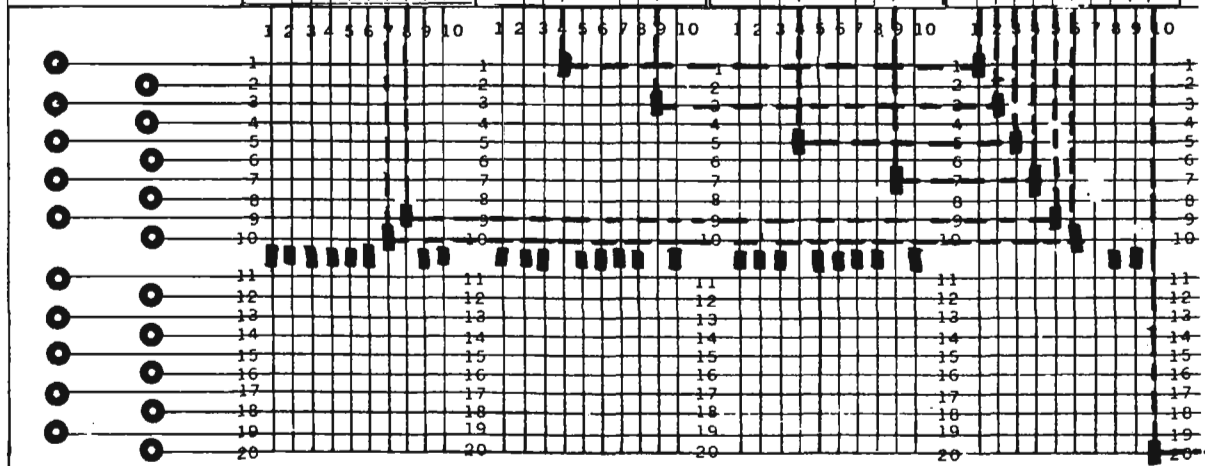
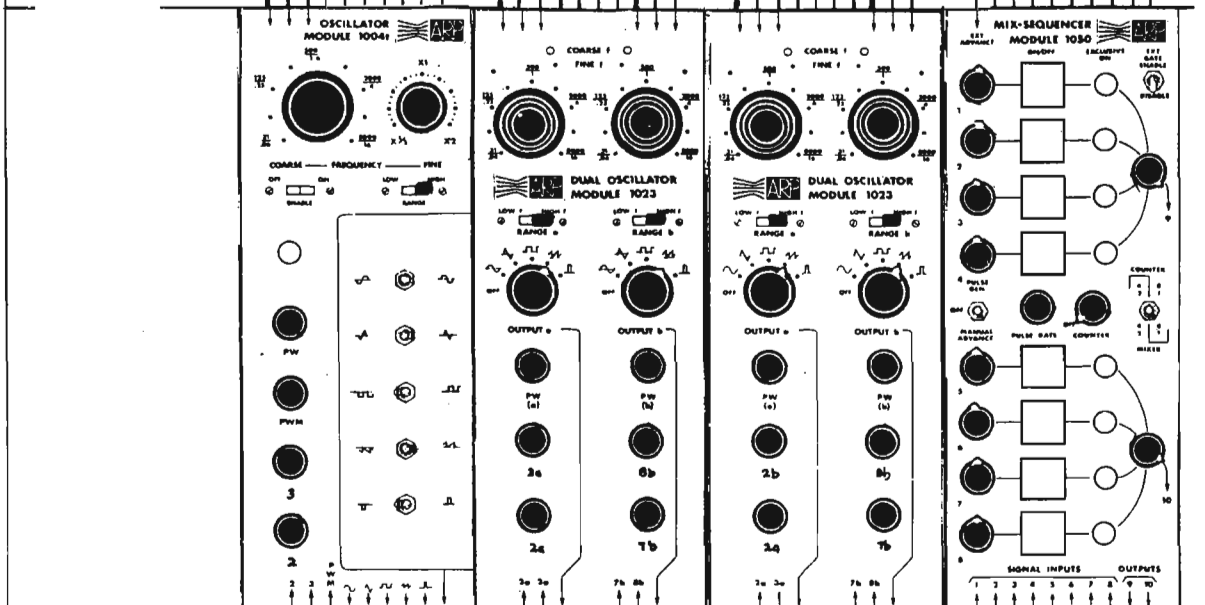
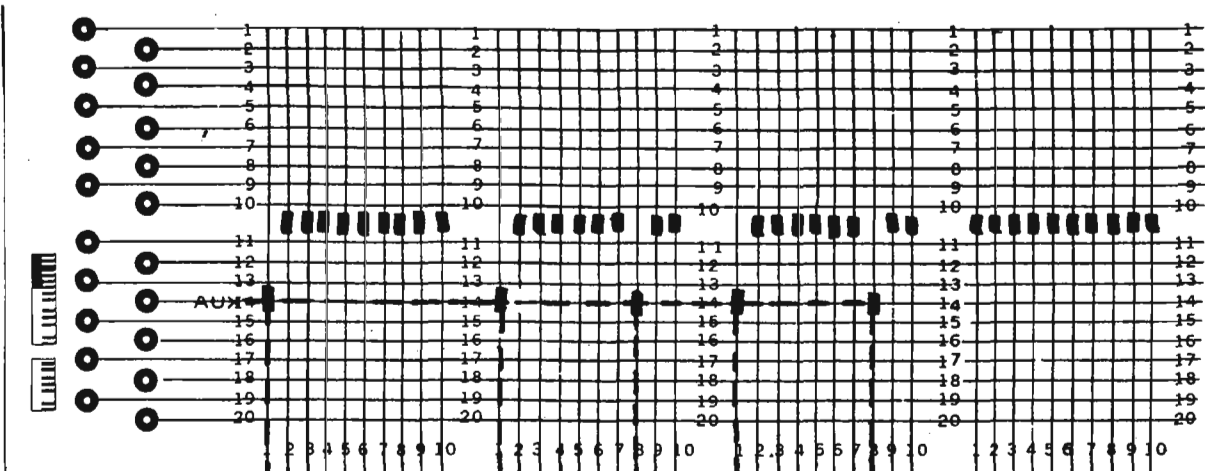

→ Amp

EXAMPLE: The 1050 can also be used as two separate 4-input mixers. In this example, one of the two mixers is used to select or mix envelope generator outputs and the other is used to select oscillator outputs. This technique can be very useful in live performance situations where the “exclusive on” buttons can be used to quickly recall a preset envelope or timbre.

Amp →

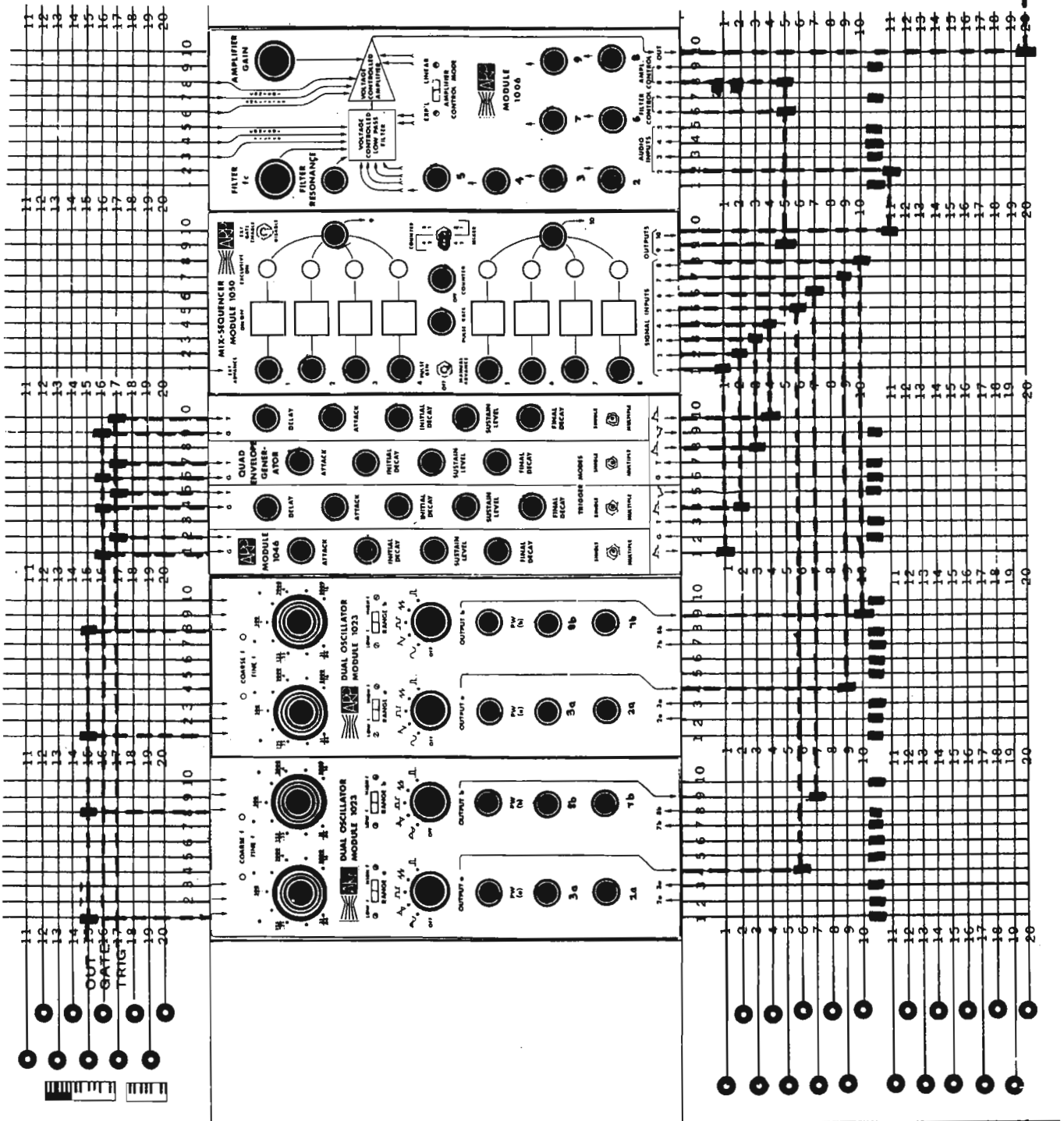

EXAMPLE: The 1050 can be used to convert the 10 x 3 format of the sequencer's 30 output controls to a 30 x 1 format. The "Counter/Mixer" switch is set to the left hand position, thereby splitting the mixer into two 4-input mixers and also splitting the counter into a parallel-count operation. The A, B, and C columns of the sequencer are fed into inputs 1, 2, and 3 of the 1050. Each time the sequencer counts through all ten steps, the counter in the 1050 is advanced one step by coupling its "Ext Advance" input to the 1st position gate output of the sequencer. Therefore, the 1050 can be used to automatically "scan" the three output columns of the sequencer.

The lower half of the 1050 can be used to process position gate outputs. Shown in the diagram is a scheme which causes the sequencer to reset on the 27th count. This is accomplished by feeding the 7th position gate into input 7 on the 1050. During the first 10 counts, inputs 1 and 5 are on. During the second ten, 2 and 6 are on. During the third 10 counts, inputs 3 and 7 are on. When the 27th count is reached, the 7th position gate output passes through the 1050's lower mixer section and back to the "reset" input on the sequencer. Be sure that all input and output attenuators on the 1050 are at maximum.

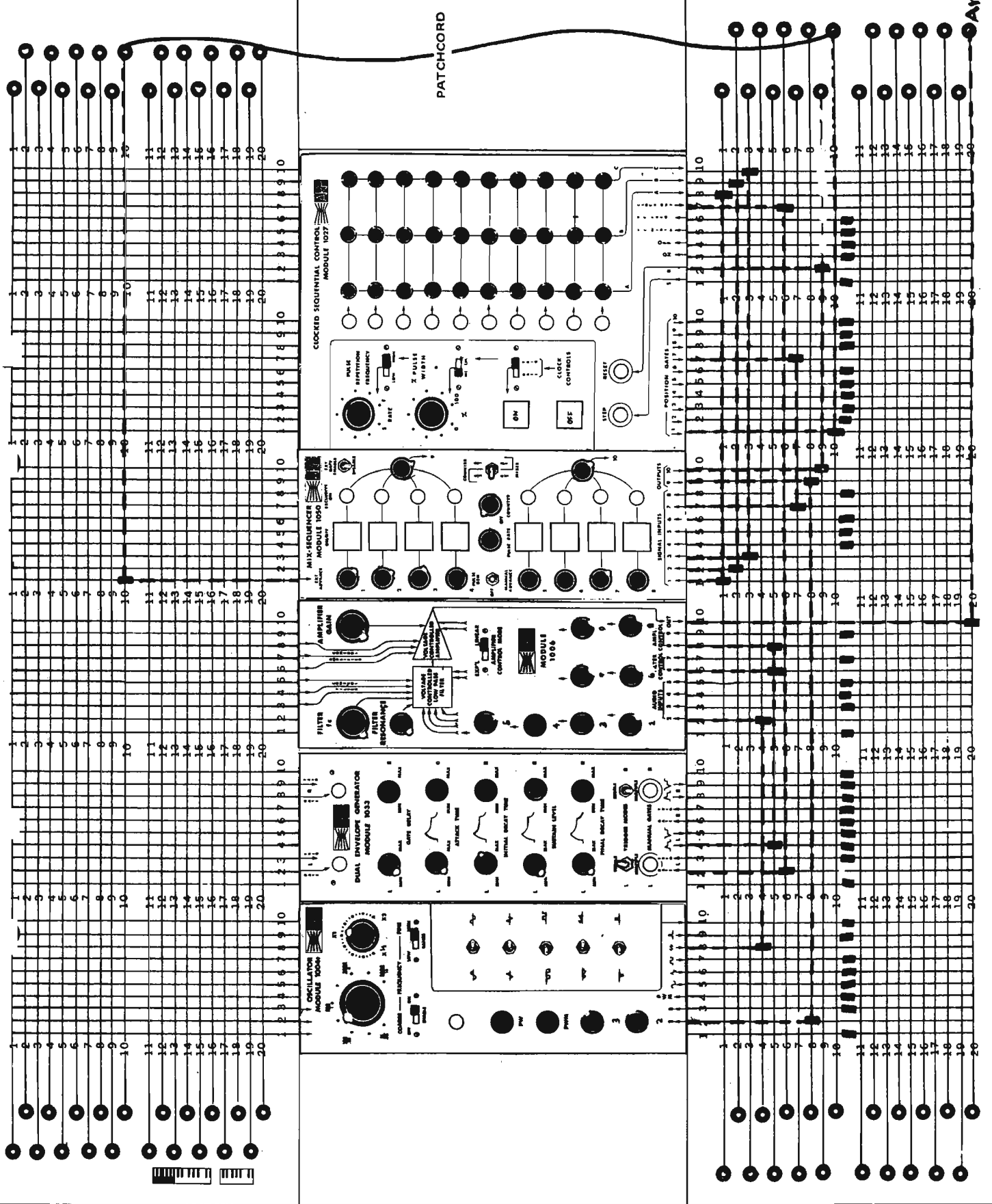

SAMPLE & HOLD

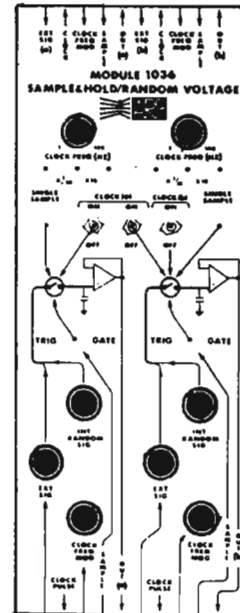

1036 Sample and Hold Circuit

A sample and hold circuit is designed to “look at” an input voltage at some instant and store that voltage for an indefinite period of time. It is essentially an analog memory. In the 1036 module, it takes only a few millionths of a second to load this memory, and the memory output will be of useful accuracy for a good part of an hour.

A sample and hold circuit has many applications in creating music with the synthesizer. The sample and hold circuit can be used to provide control voltages for oscillators, filters, amplifiers, and other devices, or it can be used to process gate signals for envelope generators in conjunction with sequencers in order to produce complex or non-repetitive rhythmic structures.

The 1036 module contains two identical and electrically independent sample and hold circuits. Also included in the module is a pair of voltage-controlled pulse generators which are used to trigger the sample and hold circuits (thereby resampling the input voltage and creating a new output voltage), and two white noise sources. The following chart shows the correlation between some random input to the sample and hold circuit, the output of the sample and hold circuit, and the internal clock:

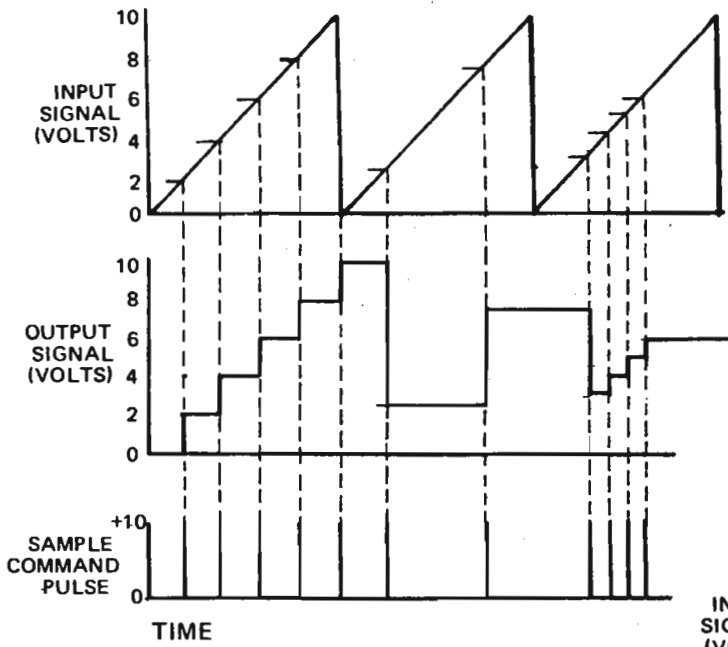

(A)

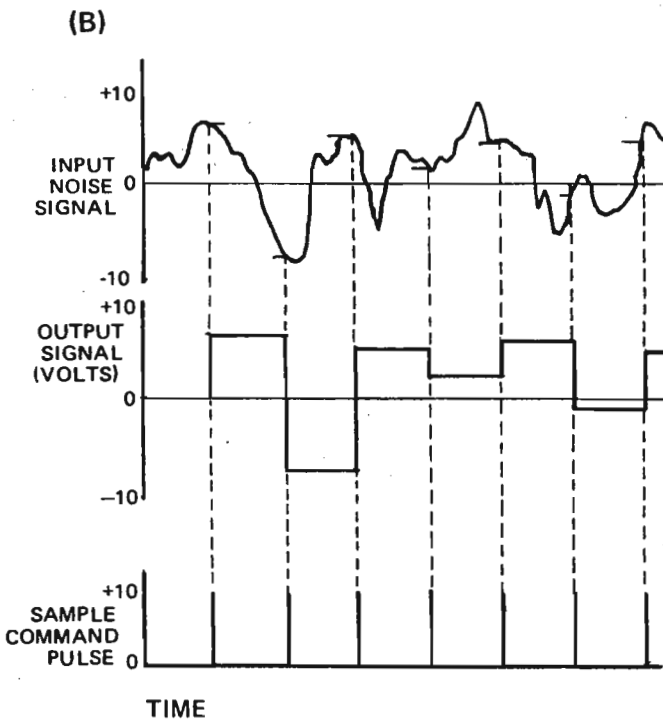

(B)

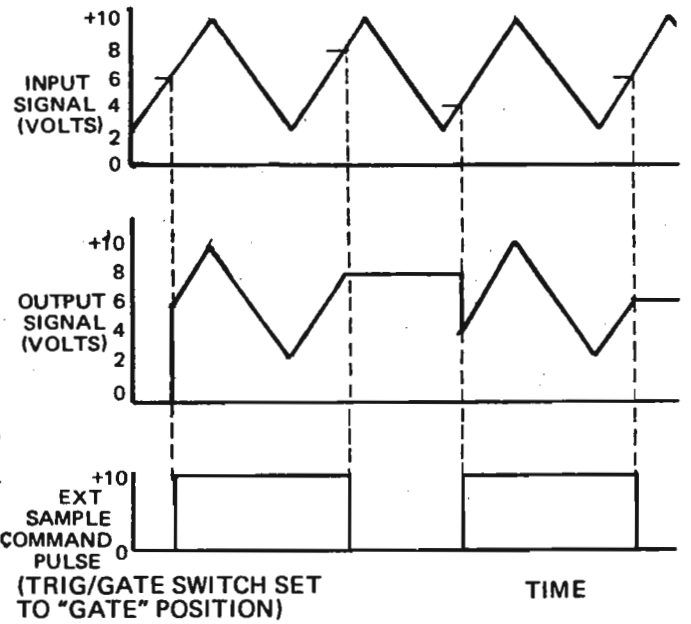

(C)

EXAMPLE: In this example, two oscillators are used to produce two tones. The pitch of each tone is determined by the output of separate sample and hold circuits. Start by listening first to the left oscillator alone. Control settings on the 1036 should be as shown. The oscillator should be producing a series of random pitches. Changing the setting of "Clock Freq A" will alter the period between pitch changes. Turning off the "Clock (a)" toggle switch will result in the indefinite holding of one pitch. The "single sample" button can be used to manually generate a new pitch. With the "Clock (a)" switch on again, note that reducing the setting of the left hand "Int Random Sig" control reduces the average difference between pitches. The two "Internal Random Signal" sources (actually white noise sources) are uncorrelated so that when the second oscillator is added to the first, the two pitches move independently. Turning off the "Clock (b)" toggle switch will cause one of the two pitches to hold constant. Turning on the center "Clock (a)" switch will cause both sample and hold circuits to be triggered from clock "a".

Return to listening to the left hand oscillator alone. Reduce the "Int Random Sig" control to minimum. The pitch should be steady. Slowly advancing the "Ext Sig" control should allow the slow sawtooth wave from the oscillator to the right of the 1036 module to appear at the input to the sample and hold circuit. When sampled periodically, the sawtooth wave becomes a "staircase" wave and produces a scale of ascending pitches. Listening again to both oscillators, two scales can be produced simultaneously. Advancing the "Clock Freq Mod" control produces the expected effect of increasing the sampling frequency as the voltage at the "Clock Freq Mod" input increases.

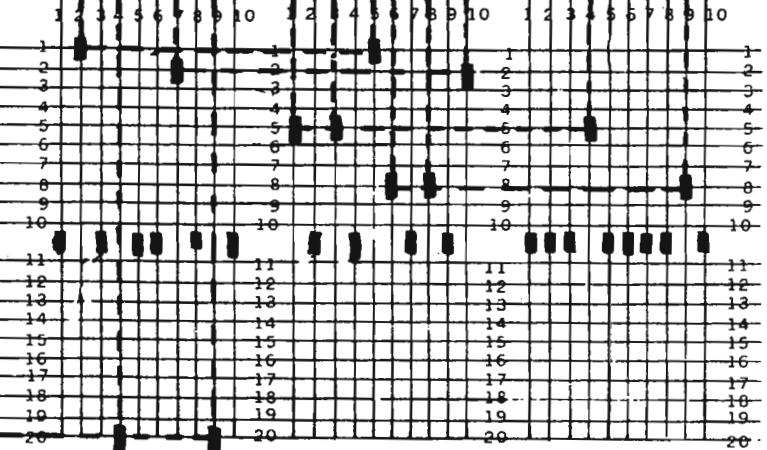
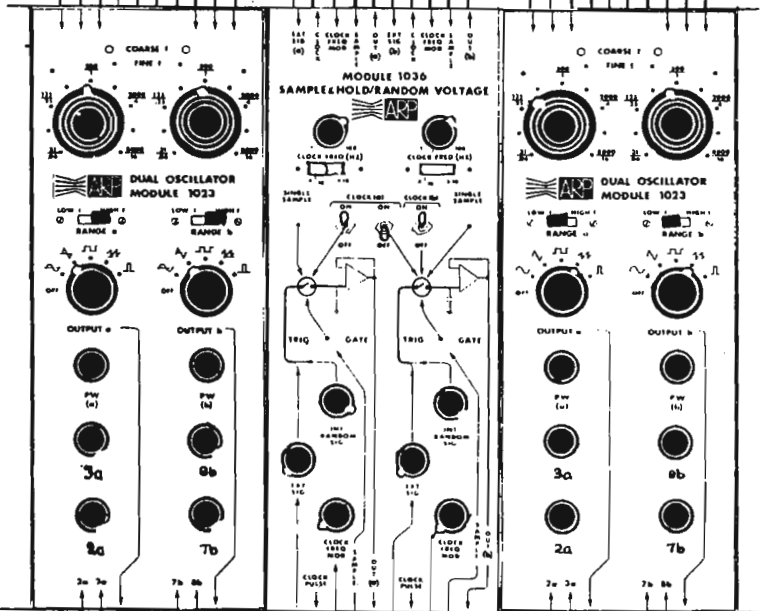
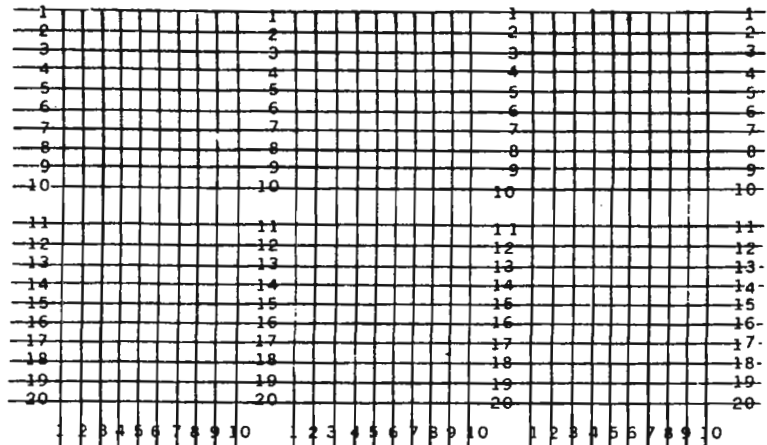

Amp ←