

PAIA
ELECTRONICS, INC.

4730

MULTI-MODAL FILTER

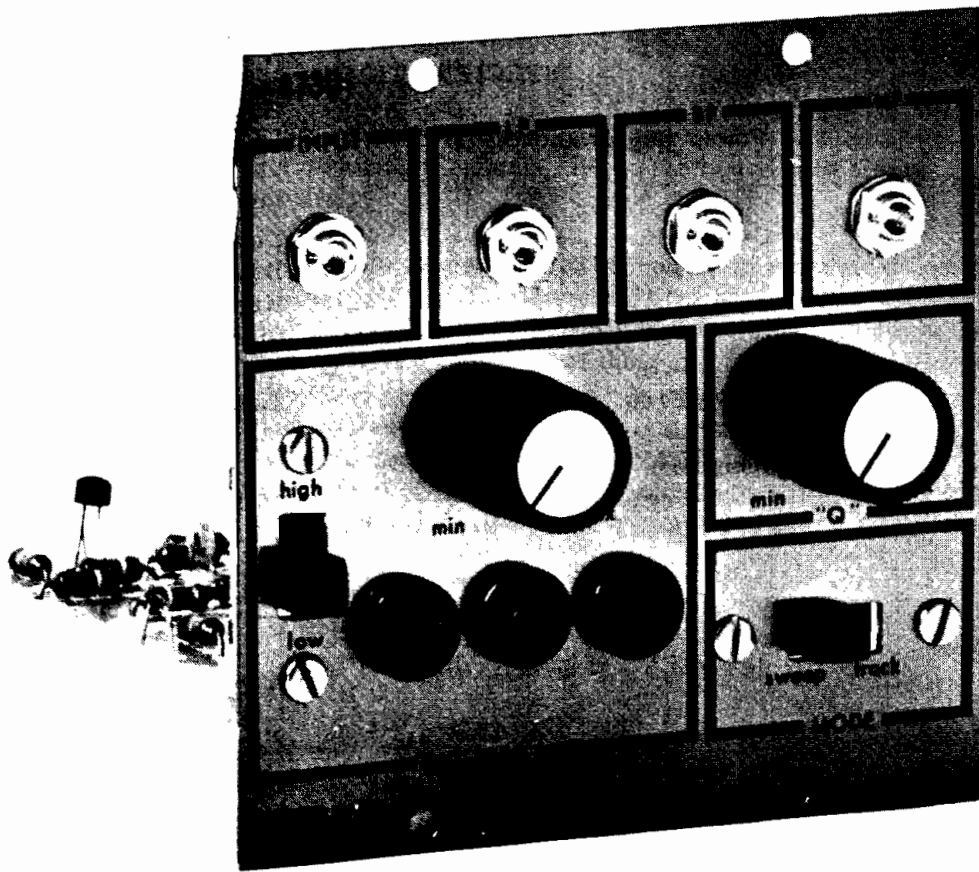

SPECIFICATIONS

Power Requirements:	+9v. @ 15ma. -9v. @ 25ma.
Outputs:	Low Pass Band Pass High Pass Simultaneously available
C.V./Freq. Response:	Linear
Ranges:	
Freq. :	16 Hz. to 16 kHz.
Q:	.5 to 150

SOLDERING

Use care when mounting all components. Use only rosin core solder (acid core solder is never used in electronics work). A proper solder joint has just enough solder to cover the round soldering pad and about 1/16 inch of the lead passing through it. There are two improper connections to beware of: Using too little solder will sometimes result in a connection which appears to be soldered but actually there is a layer of flux insulating the component lead from the solder bead. This situation can be cured by re-heating the joint and applying more solder. If too much solder is used on a connection there is the danger that a conducting bridge of excess solder will flow between adjacent circuit board conductors forming a short circuit. Unintentional bridges can be cleaned off by holding the board up-side down and flowing the excess solder off onto a clean, hot soldering iron.

Select a soldering iron with a small tip and a power rating not more than 35 watts. Soldering guns are completely unacceptable for assembling transistorized equipment because the large magnetic field they generate can damage solid state components.

CIRCUIT BOARD ASSEMBLY

- () Prepare for assembly by thoroughly cleaning the conductor side of the circuit board with a scouring cleanser. Rinse the board with clear water and dry completely.

Solder each of the fixed resistors in place following the parts placement designators printed on the circuit board and the assembly drawing figure 1 (located in the removable center section of this manual). Note that the fixed resistors are non-polarized and may be mounted with either of their two leads in either of the holes provided. Cinch the resistors in place prior to soldering by putting their leads through the holes and pushing them firmly against the board. On the conductor side of the circuit board bend the leads outward to about a 45 angle. Clip off each lead flush with the solder joint as the joint is made. **SAVE THE EXCESS CLIPPED OFF LEADS FOR USE AS JUMPERS IN LATER STEPS.**

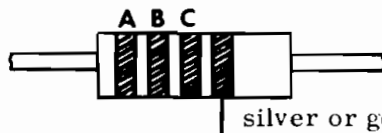

DESIGNATION	VALUE	COLOR CODE A-B-C
() R1.....	220K.....	red-red-yellow
() R2.....	220K.....	red-red-yellow
() R3.....	82K.....	grey-red-orange
() R4.....	3.9 meg.....	orange-white-green
() R5.....	220K.....	red-red-yellow
() R6.....	10K.....	brown-black-orange
() R7.....	100 ohm.....	brown-black-brown
() R8.....	100 ohm.....	brown-black-brown
() R9.....	4700 ohm.....	yellow-violet-red
() R10.....	39K.....	orange-white-orange
() R11.....	39K.....	orange-white-orange
() R12.....	10K.....	brown-black-orange

DESIGNATION	VALUE	COLOR CODE A-B-C
() R13	100 ohm	brown-black-brown
() R14	100 ohm	brown-black-brown
() R15	4700 ohm	yellow-violet-red
() R16	39K	orange-white-orange
() R17	39K	orange-white-orange
() R18	220K	red-red-yellow
() R19	330 ohm	orange-orange-brown
() R20	330 ohm	orange-orange-brown
() R21	270K	red-violet-yellow
() R22	270K	red-violet-yellow
() R23	270K	red-violet-yellow
() R24	150K	brown-green-yellow
() R25	680 ohm	blue-grey-brown
() R26	470K	yellow-violet-yellow
() R27	470K	yellow-violet-yellow
() R28	150 ohm	brown-green-brown
() R29	150 ohm	brown-green-brown
() R30	1K	brown-black-red
() R31	1K	brown-black-red
() R32	1K	brown-black-red
() R36	220K	red-red-yellow

NOTE: Not all fixed resistors are used on the circuit board. Three remaining resistors will be installed on the front panel in later steps.

- () Using three (3) pieces of excess wire clipped during resistor installation form and install the three wire jumpers as shown by the solid lines in figure 1 and printed on the circuit board.
- () Using two lengths of insulated wire install the two jumpers as indicated by the broken lines in figure 1 and printed on the circuit board.

Install the ceramic disks and mylar capacitors. Without exception the values will be marked on the body of the part.

DESIGNATION	VALUE
() C1	.1 mfd. mylar
() C3	100 pf. ceramic disk
() C4	360 pf. mylar
() C5	360 pf. mylar
() C13	15 pf. ceramic disk



NOTE: Not all ceramic disk capacitors are used on the circuit board. Two remaining disk capacitors will be installed on the front panel in later steps.
 ALSO: Mylar C1 may be labeled 100K and ceramic disk C13 may be labeled 15K.

Up to this point all components have been non-polarized and either lead could be placed in either of the holes provided without affecting the operation of the unit. Electrolytic capacitors are polarized and must be mounted so that the "+" lead of the capacitor goes through the "+" hole in the circuit board. In the event that the "-" lead rather than the "+" lead of the capacitor is marked it is to go through the unmarked hole in the circuit board.

Note that the operating voltage (v.) specified for a capacitor is the minimum acceptable rating. Capacitors supplied with specific kits may have a higher voltage rating than that specified and may be used despite this difference. For instance, a 100 mfd. 25v. capacitor may be used in place of a 100 mfd. 16v. capacitor without affecting the operation of the circuit.

Mount the following electrolytic capacitors and solder them in place. Their values, voltage rating and polarization are marked on the body of the part.

DESIGNATION	DESCRIPTION
() C2	1 mfd. 6v. electrolytic
() C6	100 mfd. 10v. electrolytic
() C7	100 mfd. 10v. electrolytic



NOTE: Not all electrolytic capacitors are used on the circuit board. Three remaining electrolytic capacitors will be installed on the front panel in later steps.

Install the transistor. Orient as illustrated in figure 1 and the parts placement designators printed on the circuit board. All semi-conductors are heat sensitive and may be damaged if allowed to get too hot while soldering. To be on the safe side, heat sink each transistor lead during the soldering operation by grasping it with a pair of needle nose pliers at a point between the circuit board and the body of the transistor.

DESIGNATION	TYPE NO.
() Q1	2N5139



Install the diode. Like transistors, diodes are heat sensitive and the precautions listed for transistor installation apply here also. The physical appearance of the diode is related to the schematic representation in the drawing below.

DESIGNATION	TYPE NO.
() D1	5.6v. zener

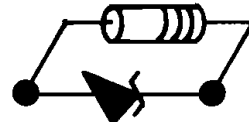

Install the integrated circuits. Note that the orientation of the integrated circuits is keyed to the notch at one end of the case which aligns with the semi-circular key on the designators printed on the circuit board. Use particular care when installing these parts. Like any other semi-conductor they are heat sensitive and should not be exposed to extraordinarily high soldering temperatures. Make sure that the orientation is correct before soldering. Once these parts are installed they cannot be removed without destroying them.

DESIGNATION	TYPE NO.
() IC-1	748 op-amp
() IC-2	LM-3900 or CA-3401E-Quad Norton Amp
() IC-3	CA-3080 Transconductance Amp
() IC-4	CA-3080 Transconductance Amp

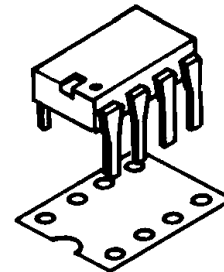
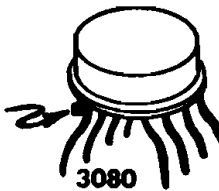

NOTE: PIN 1 DOT

Install the trimmer potentiometers.

DESIGNATION	VALUE
() R37	50K
() R38	10K
() R39	10K



In the following steps wires will be soldered to the circuit board which in later steps will connect to front panel controls and jacks. At each step prepare the wire by cutting it to the specified length and unless otherwise noted, stripping 1/4 inch of insulation from each end of the wire. "Tin" each end by twisting the exposed strands tightly together and melting a small amount of solder into the wire.

Using the insulated wire provided make the following connections to the circuit board.

- () a 5-1/4 inch length to point "B".
- () A 5-1/4 inch length to point "C".
- () A 5-1/4 inch length to point "R".
- () A 4-1/4 inch length to point "L".
- () A 4 inch length to point "M".
- () A 3-3/4 inch length to point "N".
- () A 3-3/4 inch length to point "P".
- () A 3-1/4 inch length to point "E".
- () A 3 inch length to point "D".
- () A 2-3/4 inch length to point "A".
- () A 2-3/4 inch length to point "K".

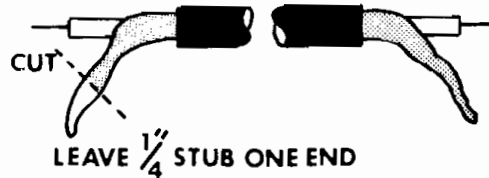

Figure 2 - Co-ax detail.

(strip 1/2 inch of insulation from the free end of this wire)

- () Locate the co-axial cable provided and cut a 4-3/4 inch length.
- () Referring to figure 2, prepare both ends of the cable by stripping away 1/2 inch of the outer insulating sleeve to expose the shielding wire. Using a pencil or other suitable pointed object, carefully unbraid the shielding wire, pull to one side, twist tightly together and "tin". This will leave approximately 1/2 inch of the insulated inner conductor exposed. Strip 1/4 inch of the insulation from the inner conductor and twist and "tin" the exposed strands. At one end of this piece of co-ax, cut the shield so that a stub 1/4 inch long remains (see figure 2). In a later step this stub will connect to the circuit board. DO NOT shorten the shield at the other end of the co-ax.
- () Prepare the remaining piece of co-ax in the same manner as described above.
- () Connect the shielding wires of the longer of the two lengths of co-ax to circuit board point "F". Be sure to use the stub.
- () Connect the inner conductor of the above co-ax to circuit board point "G".

- () Connect the inner conductor of the remaining length of co-ax to circuit board point "J".
- () Connect the shielding wires of the above co-ax to circuit board point "H".
(Be sure to use the stub.)

THIS COMPLETES ASSEMBLY OF THE 4730 CIRCUIT BOARD. TEMPORARILY SET THE CIRCUIT BOARD ASIDE AND PROCEED TO THE MOUNTING OF THE FRONT PANEL CONTROLS AND JACKS.

Place the front panel face down on a soft rag during these operations to prevent marring the finish.

- () Place a black pin jack J5 in the hole provided as shown in figure 4 and fasten in place with a Tinnerman nut as shown in detail drawing figure 3. Press the tinnerman nut down firmly.

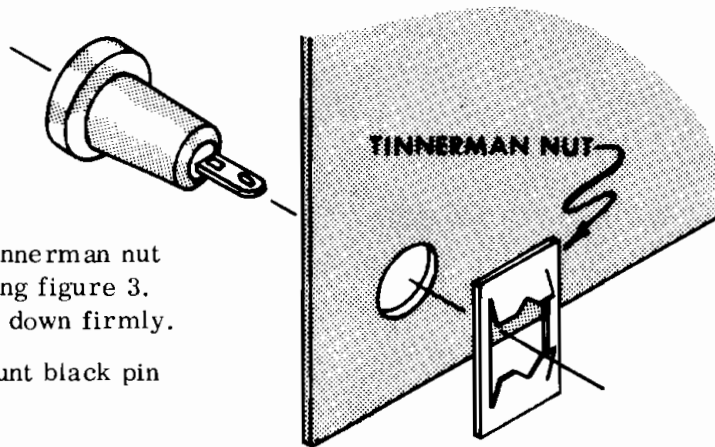
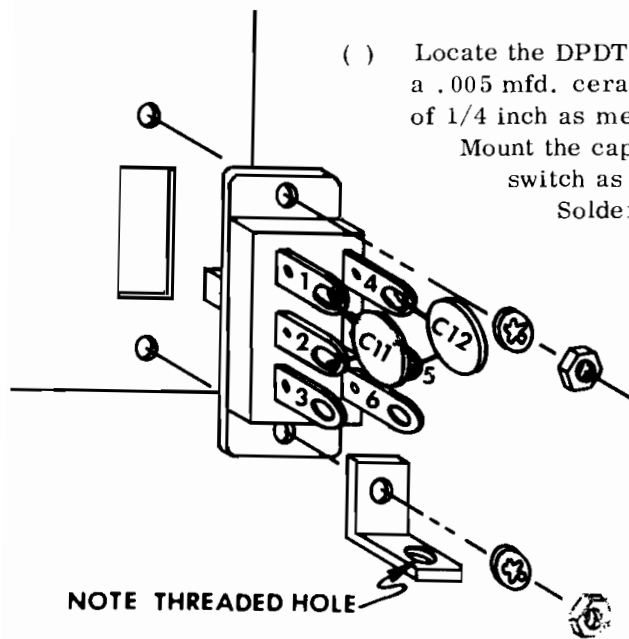

Figure 3 -
Tinnerman nut mounting detail.

- () In a similar manner mount black pin jack J6.
- () In a similar manner mount black pin jack J7.
- () Mount the open circuit phone jack J1 on the front panel in the position shown in figure 4. Orient the jack as illustrated and fasten in place with the nut provided.
- () In a similar manner mount the open circuit phone jack J2.
- () In a similar manner mount the open circuit phone jack J3.
- () In a similar manner mount the open circuit phone jack J4.
- () Mount the 100K dual section potentiometer R40 in the location shown in figure 4. Use two 3/8 inch nuts provided, one behind the front panel as a spacer, and the second on the front side of the panel to secure the potentiometer. Adjust the rear nut so that none of the threaded shaft is exposed when the front nut is tightened down. This will allow the control knob, which will be mounted in a later step, to seat as closely as possible to the front panel. Orient the potentiometer so that the solder lugs face up (toward the top edge of the panel).
- () In a similar manner mount the 100K potentiometer R41. Orient as illustrated in figure 4.



NOTE THREADED HOLE

Figure 5 -
DPDT slide switch capacitor mounting detail.

- () Locate the DPDT slide switch S1. Cut both leads of a .005 mfd. ceramic disk capacitor (C11) to a length of 1/4 inch as measured from the body of the part. Mount the capacitor between lugs #1 and #2 of the switch as shown in detail drawing figure 5. Solder the connection at lug #2 ONLY.

- () In a similar manner, prepare and mount a second .005 mfd. ceramic disk capacitor (C12) between lugs #4 and #5 of the switch. Solder the connection at lug #5 ONLY.

- () Using two 4-40 X 1/4 inch machine screws, two lock-washers, two 4-40 nuts and one "L" bracket mount the slide switch S1 as shown in detail figure 5.

TEMPORARILY SET ASIDE THE FRONT PANEL AND PROCEED TO THE CONSTRUCTION OF TERMINAL STRIP TS-1.

- () Locate the 9 lug terminal strip provided and using a pair of diagonal cutters, or other suitable tool, cut as shown in figure 6. Pay particular attention that the terminal strip is oriented exactly as shown in figure 6.
- () Solder a length of the bare wire provided between lugs #1 and #2 of TS-1 at the point where the lugs are rivited to the phenolic strip.
- () Connect a 470 ohm resistor R35 (yellow-violet-brown) between lugs #2 and #3 of TS-1. DO NOT SOLDER.
- () Connect a second 470 ohm resistor R34 (yellow-violet-brown) between lugs #2 and #4 of TS-1. DO NOT SOLDER.
- () Connect a third 470 ohm resistor R33 (yellow-violet-brown) between lugs #2 and #5 of TS-1. Solder three wires at lug #2 only.

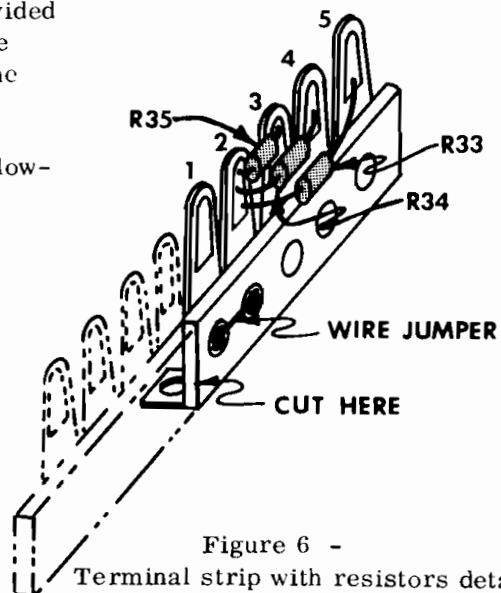
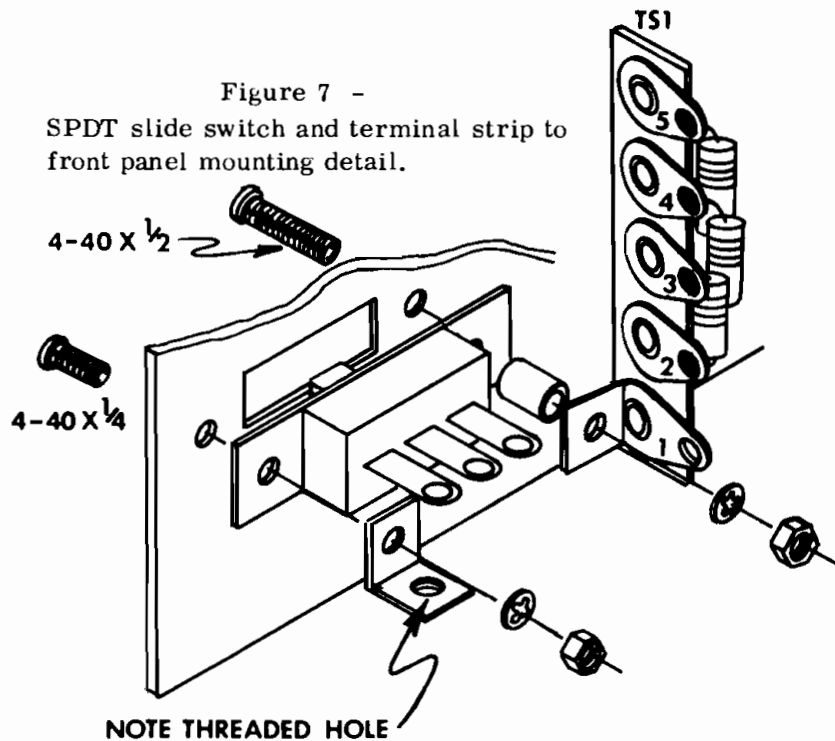

Figure 6 -
Terminal strip with resistors detail.

- () Using one 4-40 X 1/4 inch machine screw, one #4 lockwasher, one 4-40 X 1/2 inch machine screw, one "L" bracket, one 5/16 inch spacer and two 4-40 nuts mount the SPDT slide switch S2 along with terminal strip TS-1 to the front panel as shown in detail drawing figure 7.

REFERRING TO FIGURE 4, WIRE THE FRONT PANEL CONTROLS AS FOLLOWS:

- () Using a 1-1/4 inch length of insulated wire make the connection between lug #1 of TS-1 and lug #3 of S2. SOLDER THE CONNECTION AT LUG #3 of S2 ONLY.
- () Using a 2-3/4 inch length of insulated wire make the connection between lug #1 of TS-1 and lug #3 of R41. SOLDER THE CONNECTION AT LUG #3 of R41 ONLY.



- () Using a 3 inch length of insulated wire make the connection between lug #1 of TS-1 and lug #3 of R40. DO NOT SOLDER.
- () Using the bare wire provided make the connections between lug #3 of R40 (solder two wires at this point), lug #2 of J4 (SOLDER), lug #2 of J3 (SOLDER), lug #2 of J2 (SOLDER) and lug #2 of J1 (SOLDER). At J2, J3 and J4 this wire need only pass through the hole in the lug. A tight crimp connection is not necessary.
- () Strip 1/2 inch of insulation from one end of a 3-1/2 inch length of insulated wire and make the connection between lugs #5 and #6 of R40. Solder both connections.
- () Connect the other end of the above wire to lug #1 of J1 and solder.

- () Using a 5-1/2 inch length of insulated wire make the connection between lug #1 of R40 and lug #6 of S1. SOLDER THE CONNECTION AT LUG #1 OF R40 ONLY.

IN THE FOLLOWING STEPS, AS EACH LENGTH OF INSULATION IS SLIPPED OVER A LEAD, CUT THE LEAD SO THAT 1/4 INCH EXTENDS BEYOND THE END OF THE TUBING.

- () Cut a 1/2 inch length of tubing and slip it over the NEGATIVE lead of a 2.2 mfd. electrolytic capacitor (C9). Connect this lead to lug #4 of TS-1. DO NOT SOLDER.
- () Cut a 1/2 inch length of tubing and slip it over the POSITIVE lead of the previously installed capacitor. Connect this lead to lug #1 of J3. SOLDER.
- () Cut a 1/2 inch length of the plastic tubing provided and slip it over the NEGATIVE lead of a second 2.2 mfd. electrolytic capacitor (C8) and connect to lug #5 of TS-1. DO NOT SOLDER.
- () Cut a 3/4 inch length of tubing and slip it over the POSITIVE lead of the previously installed capacitor. Connect this lead to lug #1 of J4. SOLDER.
- () Cut a 1/2 inch length of tubing and slip it over the NEGATIVE lead of a third 2.2 mfd. electrolytic capacitor (C10). Connect this lead to lug #3 of TS-1. DO NOT SOLDER.
- () Cut a 3/4 inch length of tubing and slip it over the POSITIVE lead of the previously installed capacitor. Connect this lead to lug #1 of J2. SOLDER.

THE FRONT PANEL MAY NOW BE BOLTED TO THE CIRCUIT BOARD AS FOLLOWS:

- () Using two 4-40 X 1/2 inch machine screws and two 1/4 inch spacers fasten the circuit board to the threaded holes in the "L" brackets previously attached to the front panel as shown in detail drawing figure 8.

REFERRING TO FIGURE 9 MAKE THE FINAL FRONT PANEL CONNECTIONS AS FOLLOWS:

- () Connect the wire coming from circuit board point "A" to lug #4 of R40. SOLDER.

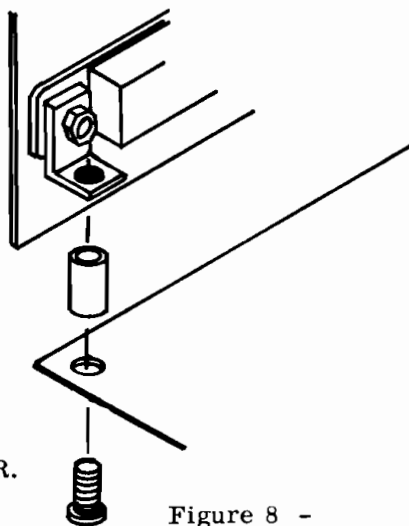

Figure 8 -
Circuit board to front panel mounting detail.

- () Connect the wire coming from point "B" to lug #5 of terminal strip TS-1. SOLDER THREE WIRES.
- () Connect the wire coming from point "C" to lug #4 of terminal strip TS-1. SOLDER THREE WIRES.
- () Connect the wire coming from point "D" to lug #3 of terminal strip TS-1. SOLDER THREE WIRES.
- () Connect the wire coming from point "E" to lug #2 of R40. SOLDER.
- () Connect the wire coming from point "K" to lug #1 and #2 of R41. SOLDER.
- () Connect the wire coming from point "L" to pin jack J5. SOLDER.
- () Connect the wire coming from point "M" to pin jack J6. SOLDER.
- () Connect the wire coming from point "N" to pin jack J7. SOLDER.
- () Connect the wire coming from point "P" to lug #2 of the SPDT slide switch S2. SOLDER.
- () Connect the wire coming from point "R" to lug #1 of terminal strip TS-1. SOLDER FOUR WIRES AT THIS POINT.
- () Connect the shielding wires of the co-ax coming from points "H" and "J" to lug #3 of the DPDT slide switch S1. SOLDER.
- () Connect the inner conductor of the co-ax coming from points "H" and "J" to lug #1 of the DPDT slide switch S1. SOLDER TWO WIRES.
- () Connect the shielding wires of the co-ax coming from points "F" and "G" to lug #6 of the DPDT slide switch S1. SOLDER TWO WIRES.
- () Connect the inner conductor of the co-ax coming from points "F" and "G" to lug #4 of the DPDT slide switch S1. SOLDER TWO WIRES.
- () Rotate the control shafts fully counter clockwise as viewed from the front panel.
- () Once the control knobs have been installed they will be difficult to remove. Before installing the knobs align the pointer of each knob so that it points to the seven o'clock position. Push the two knobs firmly onto their shafts.
- () Three flea clips have been included to facilitate power supply connections. Insert these clips into the holes in the end of the circuit board marked "+", " $\frac{+}{-}$ " and "-". These clips are a tight fit. It may be necessary to bend the narrow end of the clips slightly so that they will fit the holes.
- () Insert a fourth flea clip in the circuit board point marked TP-2 and solder.

THIS COMPLETES ASSEMBLY OF THE 4730 VOLTAGE CONTROLLED FILTER.

4730 CALIBRATION

The 4730 multi-modal filter is a high technology device and its calibration procedure is tricky at best. We strongly recommend that you follow the outlined procedure exactly the first time through. After some experience working with the module you will probably develop calibration short-cuts of your own but these must wait until you have acquired a thorough knowledge of the units eccentricities.

Begin by applying power to the clips on the rear edge of the circuit board. "+" goes to +9v. ; "-" to -9v. and the clip with the ground symbol (\oplus) connects to the common point of the two supplies.

Apply a measured source of 5 volts to one of the front panel control voltage inputs and set the front panel controls as follows: INIT FREQ control to "max", HIGH/LOW switch to "HIGH", "Q" control to "max" and the SWEEP/TRACK switch to "SWEEP".

The three internal trimmers are labeled according to the functional stage of the device which they control; HIGH PASS (R37), BAND PASS (R38) and LOW PASS (R39). For convenience, we will designate these trimmers as HP, BP and LP respectively. For aging purposes, set all of these controls fully counter-clockwise (CCW) as viewed from the nearest circuit board edge.

As with most equipment, you will want to let the module sit in this power on configuration for about 10-15 minutes to allow electrolytics to form and parts values to stabilize.

Meanwhile, we will use the time to preview the calibration procedure.

CALIBRATION PREVIEW

There is considerable interaction between the three internal trimmers of the 4730 and because of this calibration will be an iterative procedure; that is, one which will be repeated several times with each pass through the procedure getting us closer to our final goal.

An instruction that you will see several times will be "adjust TP-1 (2, 3) for ground". This instruction naturally means that we want to measure 0 volts at the specified test point, referenced to ground. By far the handiest instrument for making this sort of measurement is a DC coupled oscilloscope since it can easily measure both negative and positive voltages without having to switch leads or change switch settings. If you don't have a 'scope there are two other alternatives.

If you have access to a Vacuum Tube Volt Meter or Transistor Volt Meter you are in almost as good shape as with a scope because most of these devices have a "zero" control that allows the meter's zero to, in most cases, be set beyond the mid-point of the meter scale. With the "zero" adjusted so that with no voltage applied the meter pointer is at mid-scale, positive voltage will cause an up-scale deflection while negative voltage will cause deflection down-scale.

If you only have a volt-ohm meter (VOM) available you will need to build up the external circuitry shown below.

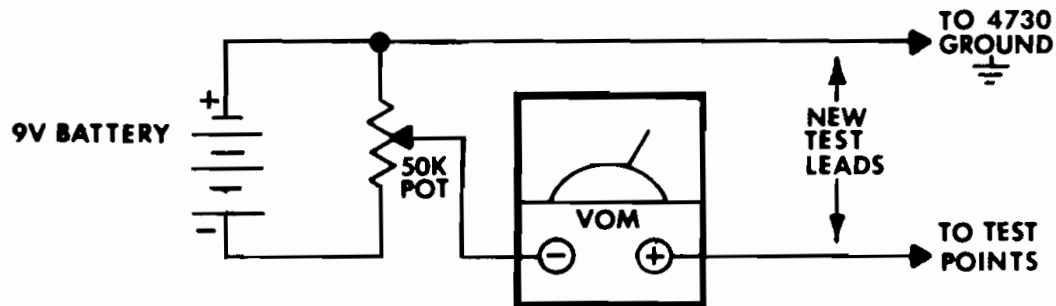

Figure 10 - Simple circuit allows VOM to measure positive and negative voltages.

This external circuitry will allow you to use you VOM to indicate both positive and negative voltages with respect to ground. The potentiometer indicated in the drawing as 50K ohms may actually be anything between 50K and 1 megohm without affecting the operation of the circuit. To calibrate the calibrator, set the VOM for a scale which can conveniently read between 10 and 20 volts (exact setting will depend on the ranges available on your meter) and with the "new test leads" connected together adjust the potentiometer for a mid-scale deflection.

When using either of these volt-meter calibration techniques you will need to remember exactly what the new "zero voltage" reading is.

The 4730 has three test points that we will be using during calibration. NOTE that while test point 2 is a flea clip on the circuit board (marked TP-2) test points 1 and 3 are lugs #6 and #3 respectively of the HIGH/LOW switch S1 as shown in figure 11. The co-ax shield that connects to these switch lugs provides ample room for the connection of test leads.

Armed with all of this valuable information and possibly new tools, we are ready to begin calibration.

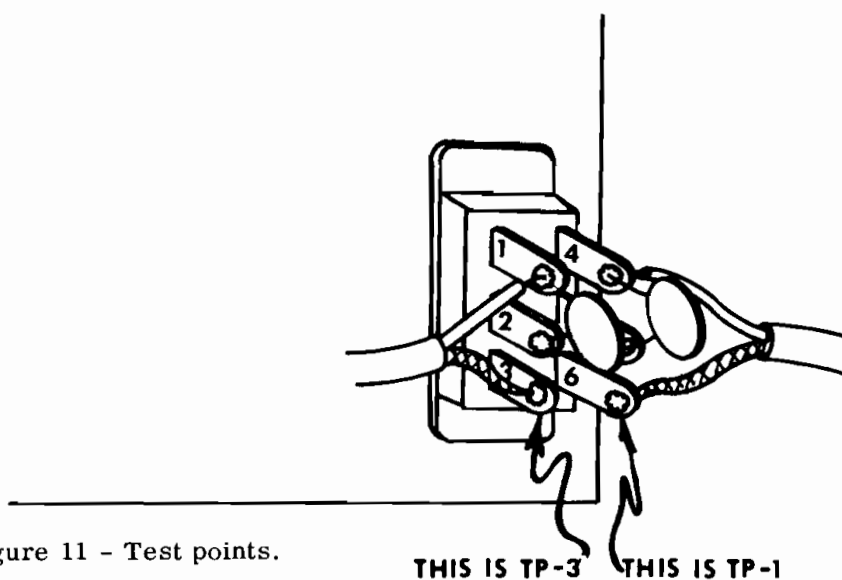

Figure 11 - Test points.

THIS IS TP-3 THIS IS TP-1

CALIBRATION

Check to make sure that all controls, trimmers and switches are still set as they were for the aging process and that 5 volts is applied to the control voltage input. Connect the ground (or negative) input of the test instrument that you will be using to the ground connection on the rear edge of the 4730 module.

- 1) While measuring the voltage at test point 1 (TP-1) adjust the LOW PASS trimmer (R39) for zero voltage at the test point. NOTE: On the first pass through this procedure it may not be possible to get exactly zero at the test points; get as close as possible.
- 2) While measuring the voltage at test point 2 (TP-2) adjust the BAND PASS trimmer (R38) for zero voltage at the test point.
- 3) While measuring the voltage at test point 3 (TP-3) adjust the HIGH PASS trimmer (R37) for zero voltage at the test point.
- 4) Repeat steps 1 through 3 until all three test points read zero voltage (within 1/4 volt is close enough) without further adjustment, then proceed to step 5.
- 5) While monitoring the voltage at TP-2 slowly rotate the front panel INIT FREQ control CCW. When the voltage at this point has changed (either increased or decreased) by greater than 1 volt stop and begin again at step 1. If the INIT FREQ control is already set to "min", disconnect the 5 volt control voltage and repeat steps 1 through 4.

USING THE 4730 MULTI-MODAL FILTER

Operation of the front panel controls and jacks is as follows:

INPUT- The input jack is in the upper left hand corner of the front panel. Input impedance is between 200K and 300K ohms depending on the setting of the "Q" control.

Recommended nominal signal level into this input is .5 v. peak-to-peak (consistent with the other modules in the 4700 and 2720 series). Signal levels greater than 1 volt peak-to-peak should be avoided as they present the possibility of overloading the module producing distortion at low frequencies and the danger of oscillation at high frequencies.

Excessively low input signal levels will cause a decreased signal to noise ratio and should be avoided.

OUTPUTS- The three remaining jacks across the top edge of the module are the LOW PASS, BAND PASS and HIGH PASS outputs. Output signal level will be dependent on the harmonic content of the input signal as well as the output being used and corner frequency of the filter, but in general can be thought of as the system nominal .5 v. peak-to-peak. Provision has been made internal to the module to keep signal levels approximately constant regardless of the setting of the "Q" control.

"Q"- The term "Q" is left over from the days when every resonant circuit had an inductor. It is derived from "quality" and originally was used as an indicator of the losses that could be expected from an inductor or transformer. But since "high Q" coils were needed to implement "high Q" resonant circuits, Q also became a property of the whole circuit rather than just the inductor itself. In technical terms, Q is the ratio of the nominal center frequency of the tuned circuit to its pass-band (ordinarily measured at the 3 db. points). A resonant circuit that has a 100 Hz. pass-band centered at 1 kHz. , then, would have a Q of 1000/100 or 10.

The 4730 Filter has a maximum Q of greater than 150, so that at a center frequency of 1 kHz. the pass-band (at the band-pass output) would only be about 6.6 Hz. wide. Figure 12 on the right shows the effect that varying the Q control has on the frequency response of the filter as measured at the Band-

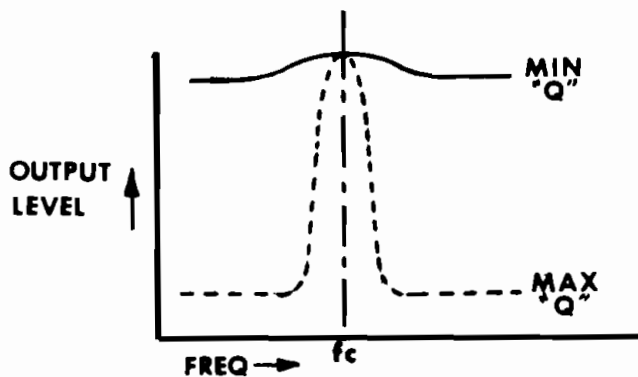

Pass (BP) output. Since this graph is a plot of output level as a function of input frequency we can see that the higher the setting of the Q control, the greater the rejection of frequencies outside the pass-band. The point that is marked f_c is the "center" frequency of the filter and the actual frequency that this point represents is a function of the settings of the controls within the INIT FREQ box. NOTE: While thinking of f_c as "center" frequency is an excellent concept for Band-Pass applications, it is also wise to think of it as "corner" frequency, as we shall see in the High Pass and Low Pass explanations.

Figure 12 - Effect of varying Q on Band-Pass output.

The graph in figure 12 is a representation of the relative signal level that we would expect to find at the Band-Pass output of the filter if the input were a sine wave of varying frequency. If the input signal is something other than a sine wave the graph can be interpreted as showing us the relative output levels of the harmonics that make up the input signal.

Figure 13 shows the effect that varying the Q control has on the High-Pass output. At the minimum Q setting the response is as you would expect from any well-behaved high-pass filter. The curve is essentially flat for frequencies higher than the corner frequency and below the corner frequency behave in the classic second order response curve by falling off at the rate of 12 db. / octave.

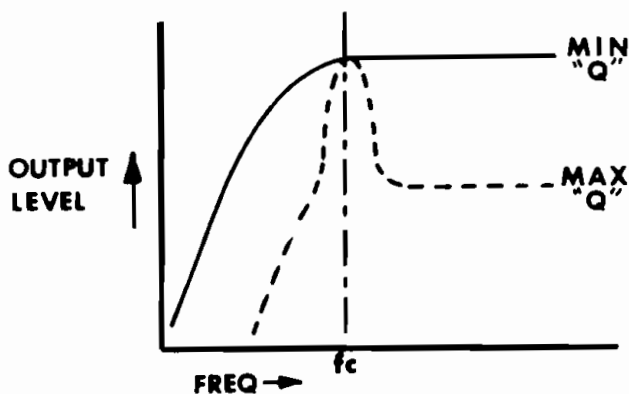

Figure 13 - Effect of varying Q on High-Pass output.

Notice, though, what happens to the high-pass output as the Q control is advanced; a resonant hump appears right at the corner frequency. Like the Band-Pass case, this curve can either represent the output level if the input to the filter is a sine wave of varying frequency, or it can represent the relative attenuation of the harmonics of a complex input signal.

Figure 14 shows what happens at the Low-Pass output. Like the High-Pass case, the curve is a classic second order response for minimum Q with frequencies above the corner frequency rolling off at the rate of 12 db./octave. Again, maximum Q generates a resonant hump in the response exactly at the corner frequency.

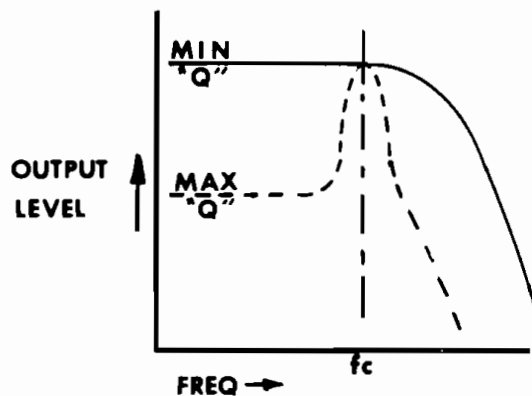

Figure 14 -
Effect of varying Q on Low-Pass output.

INIT FREQ- There are three sets of control within the INIT FREQ box that directly affect the corner frequency of the filter.

CONTROL VOLTAGE INPUTS- The three black pin jacks serve as control voltage inputs to the module. Maximum permissible input to the jacks is 5 v. total (the sum of the three inputs). Increasing the sum of the voltages into these inputs raises the corner frequency of the filter. Typical control voltage sources would be keyboard (as when tracking a filter and VCO together), Function Generator or low speed oscillators (as in swept filter effects), or fixed bias sources (when the filter is to be set to one fixed frequency).

INIT FREQ CONTROL- This knob sets the frequency corresponding to a given control voltage input and consequently serves as a variable "range" control. The key feature of this control is that it CHROMATICALLY transposes the key signature of the filter and its maximum usefulness is realized when tracking both an oscillator (or group of oscillators) and a filter to the keyboard. The total range of this control is on the order of 4 octaves and its taper is selected so that equal degrees of rotation produce equal pitch changes (as opposed to equal frequency changes which would make the control appear to have more "action" at its minimum setting than at its maximum settings). Clockwise rotation of the control increases the corner frequency corresponding to a given control voltage.

HIGH/LOW SWITCH- This switch can be thought of as "range" switch which when set to the LOW position, lowers the range of the filter by slightly more than four octaves.

MODE (SWEEP-TRACK)- In simple terms, this switch provides a constant offset to the control voltage/frequency response of the filter that is roughly equivalent to 150 Hz. when in the HIGH range and 15 Hz. in the LOW. The switch should be set to TRACK for any applications in which the filter is being controlled by a keyboard (as when tracking a VCO), and in the SWEEP mode for any application in

which the control will be going to zero volts (such as sweeping from Function Generators or Low speed oscillators). The effect that the two settings of this switch have on the internal workings of the filter are fully explained in the DESIGN ANALYSIS section of this manual and we strongly recommend that you read that section of this book.

GENERAL APPLICATION NOTES

The best way to get the feel of the 4730 filter is to play with it. Input a variety of waveforms from sine waves to square waves and short duration pulses and observe the effects that varying center frequency and Q have on the final sound.

With harmonic rich waveforms like square waves the results are more spectacular because a square wave does not consist of a single frequency and since there is more stuff there to work with the results are "busier" (which is certainly not elegantly put, but nevertheless true).

The resonant hump in the response curves that results from advancing the Q control produces an interesting effect in the filter output which is known as "ringing". Examples of this are shown in the accompanying photos. The ringing portion of the waveform is the damped (decaying) sinusoid which follows the discontinuous (rapidly changing) portions of waveforms such as ramps, pulses and square waves.

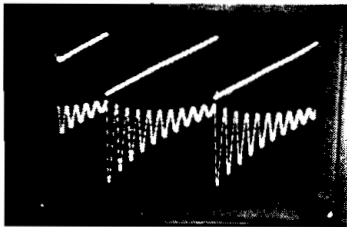

1 kHz. ramp input,
LP VCF output Fc 10kHz.

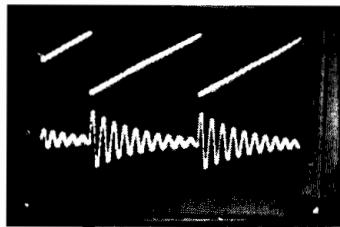

1 kHz. ramp input,
BP VCF output Fc 10kHz.

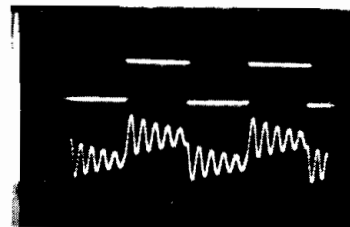

1 kHz. square wave input,
LP VCF output Fc 5 kHz.

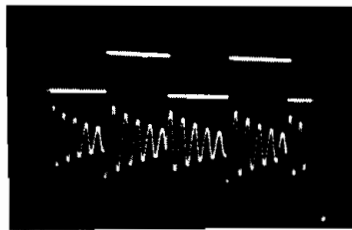

1 kHz. square wave input,
BP VCF output Fc 5kHz.

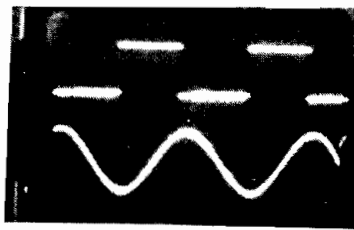

1 kHz. square wave input,
LP VCF output Fc 1 kHz.

An excellent application of this "ringing" phenomenon is the synthesis of percussion sounds without having to use the customary VCO's and VCA's. In this case, the filter tuning control voltage is derived from the keyboard's control voltage output (or function generators if the percussion effects are too atonal and random in nature) and the TRACK/SWEEP switch set to TRACK so that the filter will track the keyboard.

The "trick" here is to use a single event pulse as the audio input to the filter. There are a number of ways to get single pulses, but the most direct method is to use the pulse (or step) trigger output of the keyboard. Unfortunately, the trigger outputs of the keyboard are a much higher voltage level than the audio input of the filter can tolerate without distortion. To circumvent this problem the voltage divider shown in figure 15 may be used to reduce the voltage of the trigger outputs from their nominal 5v. level to a more useful .5v. The circuitry shown in figure 15 can be permanently wired into a special jumper cable as shown in figure 16 if desired.

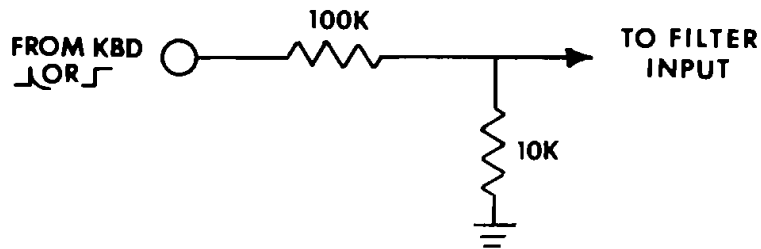

Figure 15 - An attenuator is required to apply keyboard triggers to 4730 audio input.

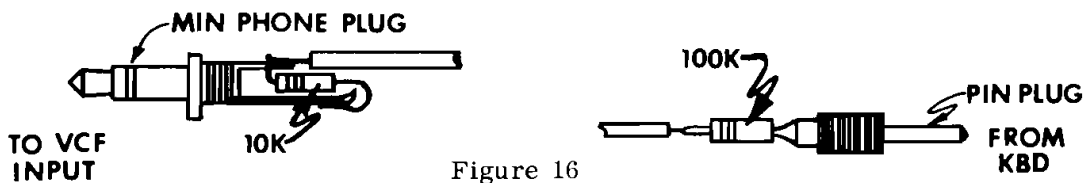

Figure 16

If you don't want to hassle around with building the voltage divider or having to worry about a special jumper, the output of a function generator (set to fastest possible attack) can be used simply by turning down the output attenuator.

Note that if a step function, rather than a pulse, is used in this application the filter will "ring" on both the leading and trailing edges of the step.

Sustain of these percussion waveforms is controlled with the 4730's "Q" control.

Noise is of course another excellent source of spectacular effects for the filter. Sounds ranging from surf, wind, thunder, explosions, etc. can be synthesized by varying Q and selecting low, band or high-pass outputs. The random control voltages that some of these sounds require can be obtained by applying the outputs of several low speed oscillators to the filter's control voltage inputs - for best results make sure that the sum of the control voltages does not exceed 5 volts.

One of the nicest features of the 4730 is that all three outputs are available simultaneously and this can be used to advantage in interesting stereo effects where one channel of the system is driven from the low-pass (or band-pass) output of the filter while the second is driven from the high-pass output.

There are other significant aspects of the simultaneity of outputs that you will undoubtedly discover for yourself and one that you may not, so we'll list it. By combining the high and low-pass outputs (either with the resistive network shown below or by using the PAIA 4711 mixer) you can get a notch filter response as shown in figure 17 below.

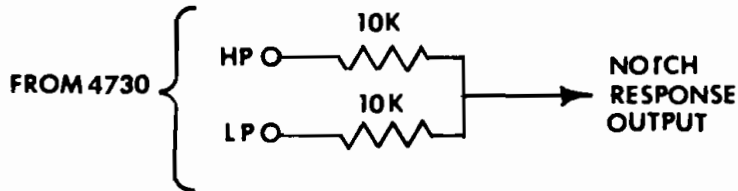

This summing network can be used to produce a "notch" filter.

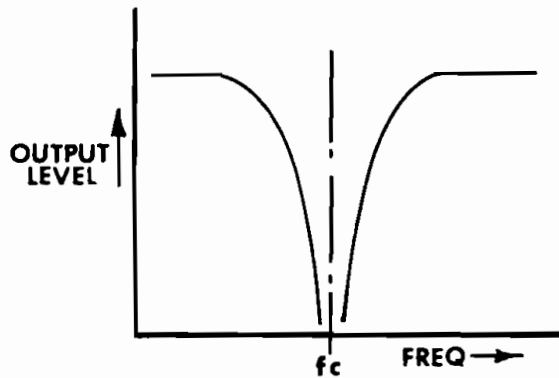
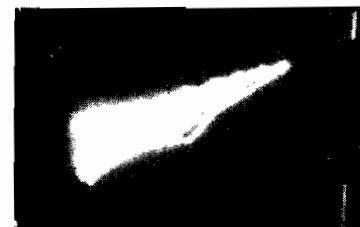
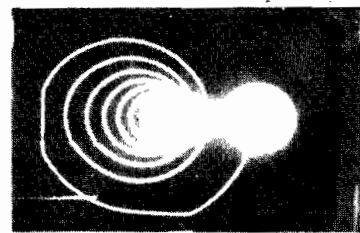
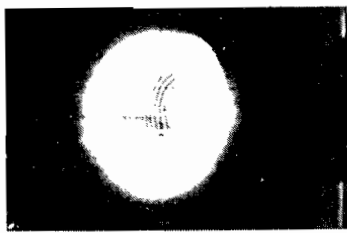

Figure 17

FILTER ART

Historically, art and technology are interrelated and more than occasionally interdependent disciplines. While the 4730 has obvious artistic applications relating to music, it also can be used in an unusual type of visual art that has been called both "filter art" and "scope art". Examples are shown below.



These oscilloscope traces were produced using the equipment arrangement shown in figure 18. Basically, these are all ringing waveforms resulting from exciting the filter with ramp and rectangular pulse waveforms. Various patterns can be realized by changing almost any parameter of the system including; VCO frequency and pulse duty factor, VCF "Q", corner frequency and the outputs used. The circular nature of the displays is a result of the fact that the Low Pass and Band Pass outputs of the filter are always at quadrature (90° phase difference between the two). Under overload conditions, there is also a slight phase difference between the Low and High Pass outputs.

When duplicating these Lissajous-type figures you will in general want to keep the oscillator frequency lower than the corner frequency of the filter and in most cases will want to keep the "Q" of the filter relatively high (though interesting patterns also result from ignoring both of these rules).

One caution - many oscilloscopes will not have sufficient gain in their horizontal amplifiers to produce adequate displacement on this axis. Under these conditions a small outboard amplifier should be added to this input. Appropriate amplifiers would be the PAIA 1710 or 2720-12 or, for that matter, any small amplifier with a voltage gain on the order of 10.

For another variation, try driving the filter with normal program material (the output of a radio or stereo works well). There are no examples of the constantly changing patterns produced under these circumstances primarily because they are extremely difficult to photograph.

As with musical applications of the filter, experimentation is the key to understanding, and understanding the key to results.

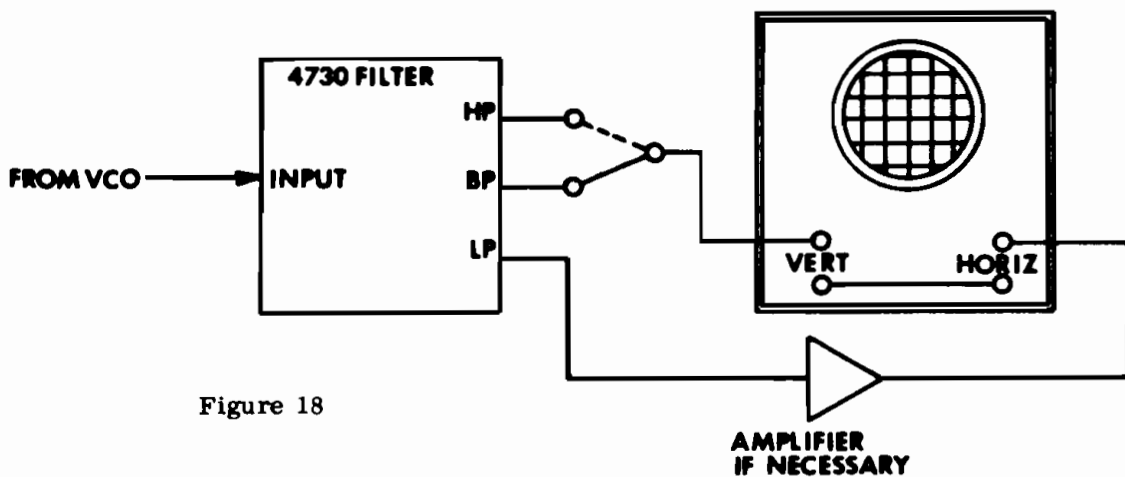

Figure 18

DESIGN ANALYSIS

The 4730 multi-modal filter is based on a design that goes by the technical name "Second Order State Variable Network". Without exaggerating to any great degree, it is essentially a special purpose analog computer that is constantly solving a set of equations that mathematically describe the behavior of a pendulum.

A simplified block diagram of the circuit looks like this:

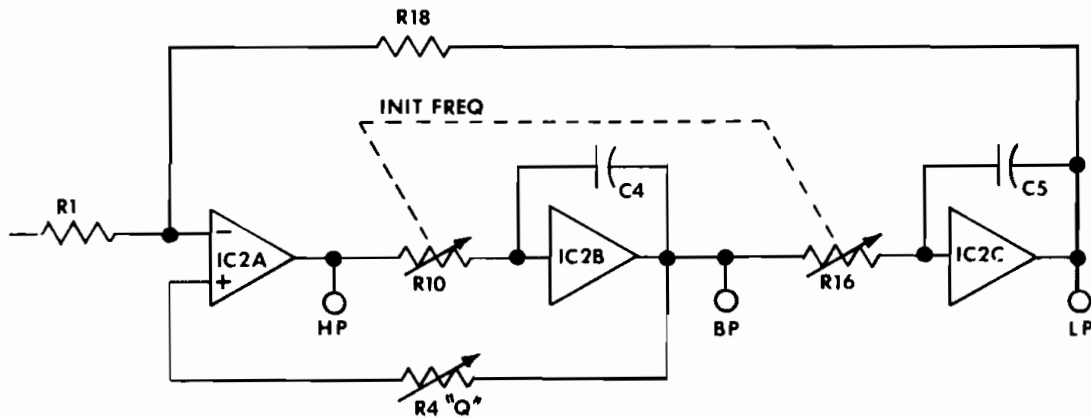

Figure 19

When viewed from this perspective, we can see that the basis of the circuit is no more elaborate than a couple of integrators and a summing amplifier. Band-Pass and Low-Pass output functions are available at the outputs of the first and second integrators respectively while the High-Pass function appears at the output of the summing block represented by IC2a.

Our real-life circuit shown in figure 20 is a lot more complicated than this because the actual module needs things like: a means to voltage control the frequency (as opposed to the potentiometer represented by R10 and R16 of the block diagram), biasing, control voltage summation and so on. Notice that the component labels in the block diagram roughly correspond to labels used in the complete schematic.

In order to voltage control this module, the first thing that we need is a way to sum the control voltages together. This task is handled by the summing voltage to current converter that comprises operational amplifier IC1, Q1, the INIT PITCH control R41 and associated components. A complete and detailed analysis of this sub-circuit is provided in the PAIA 4720 Voltage Controlled Oscillator manual.

The output of the summing V/I converter is split and balanced by resistors R19 and R20 and used to control the gain of the operational transconductance amplifiers (OTA) which replace the INIT FREQ resistors shown in the block diagram.

An OTA is simply a current controlled amplifier. As the current pumped into the control inputs of these elements is increased, the gain of the amplifier increases. Since increasing the magnitude of the signal applied to the input resistor of an integrator is equivalent to decreasing the value of the resistor, increasing the control current into the OTA effectively increases the corner frequency of the integrators and consequently the frequency of the filter.

The integrators, as well as the input summing block, are built up from three stages of the quad current differencing amplifier IC2. Adjustable bias currents to the integrators and front end summer are supplied by trimmer resistors R38, R39 and R37.

Perhaps the only draw-back to state variable filters relates to the fact that the natural tendency of the output of an integrator is to drift to saturation, so that it is for all practical purposes impossible to set an integrator at a specific output voltage and expect it to stay there. In the state variable design, the quiescent output of the integrators is held steady by the two negative feed-back loops through R18 and R4.

But the resistors at the input to the integrators (R10 and R16) are also part of these loops, and, as we have already seen, the corner frequency of the filter is lowered by effectively increasing the value of these resistors. Increasing these resistances also decreases the amount of stabilizing feed-back available to keep the integrators "locked" so that as the corner frequency is pushed lower and lower a point will eventually be reached at which there is simply not enough feed-back to keep the integrators locked and their outputs will go flying off in opposite directions.

The equivalent frequency at which this phenomenon occurs is more a function of the care used during calibration than any other single thing, but it's important to realize that even the most careful job of calibrating will not prevent its happening entirely. For example, when zero control voltage is applied to the filter the OTA's will effectively be off and the feed-back loops completely open. At this point the integrators will be unstable no matter how carefully calibrated they are.

If the filter is being used to track a keyboard this is not a problem because there will always be some voltage applied to the inputs. But, there are cases where the control voltage will be supplied by a source that is capable of going to zero control volts (sweeping effects using low speed oscillators or function generators) and for these cases the SWEEP/TRACK switch S2 was added to the circuit.

When S2 is in the SWEEP position it causes a small current to flow through R26 and R27 into the control inputs of the OTA's. This current is of sufficient magnitude to provide enough feed-back to keep the integrators stable.

The current supplied to the OTA's when S2 is in the SWEEP position represents a frequency offset of about 150 Hz., which means that with the switch in this position it would not be possible to reach the lower 3 octaves of the filters response. To get around this problem the HIGH/LOW switch S1 was added. With S1 in the LOW position, the integrator capacitors C4 and C5 are paralleled by capacitors C11 and C12 and the resulting increased capacitance allows the lower frequency end of the filters response to extend well below 15 Hz.

Note, though, that if the filter is carefully calibrated its range (with S2 in the TRACK position) will be the full 15 Hz. to 15 kHz without having to switch S1 to the LOW position.

Symptoms of integrator instability would be pops or thumps from the outputs of the filter (particularly the Low Pass output) following rapid changes in the control voltage or, in extreme cases, complete loss of signal flow through the filter.

Variable "Q" control is provided by one section of the potentiometer R40. Rotating the wiper of this potentiometer away from ground causes an increased signal flow through the feed-back path R5 and C2 which in turn increases the damping of the circuit and results in lower Q. This action also produces lower signal gain through the filter and to compensate for this the second section of R40 serves as an input attenuator which provides greater attenuation as the Q of the filter is increased.

Power supply decoupling is provided by R28, R29, C6 and C7. While the filter itself is not very supply voltage sensitive, zener diode D1 was added to help stabilize the negative supply line under the wide range of current drawn through the V/I converter.

For More Information You May Want To Read:

Lancaster, Don - "Imitating Musical Instruments with Synthesized Sound"; Popular Electronics, Vol. 8, No. 2, August 1975, pp. 39-44

Lancaster, Don - "Active Filter Cookbook"; Indianapolis: Howard W. Sams & Co., Inc., 1975

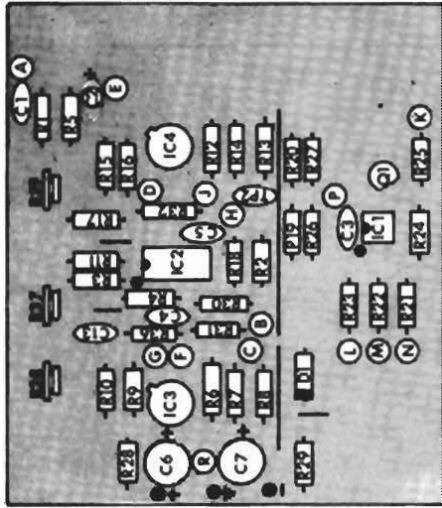

Figure 1 - Circuit board parts placement.

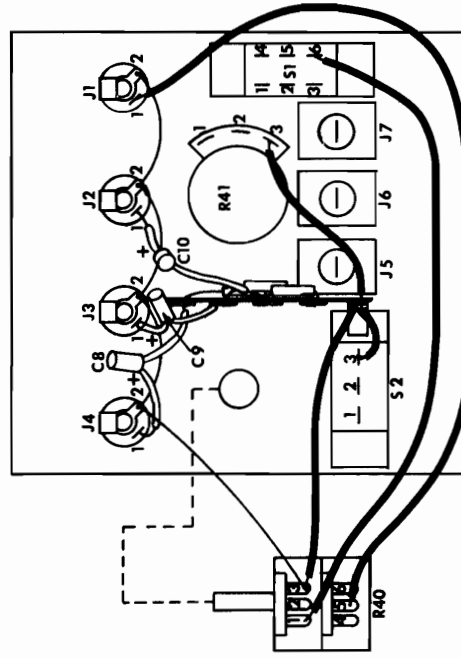

Figure 4 - Front panel layout and wiring.

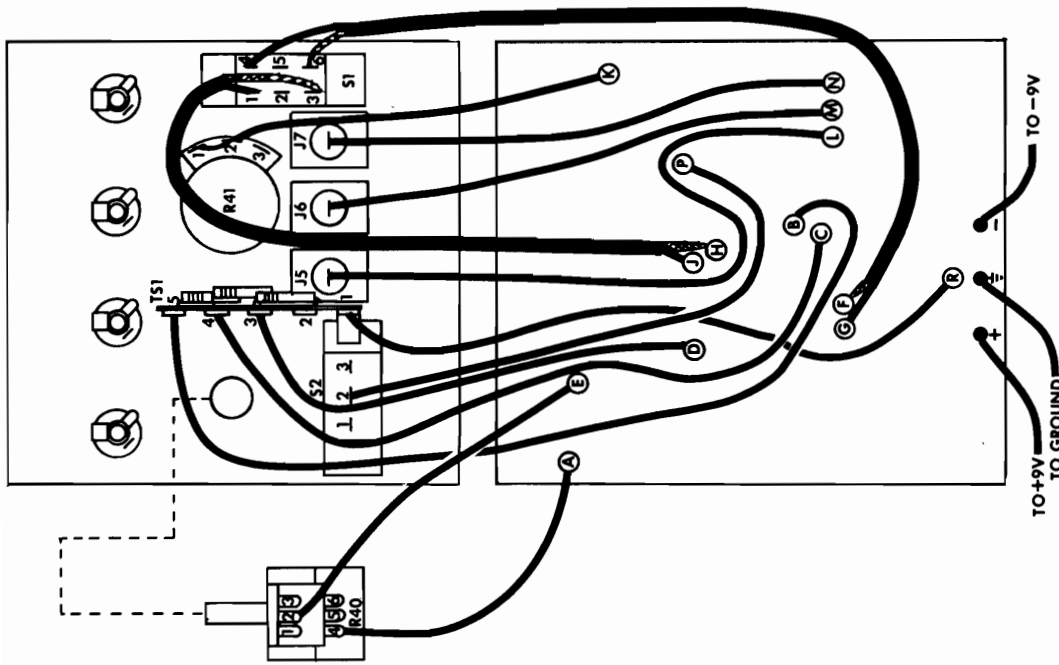
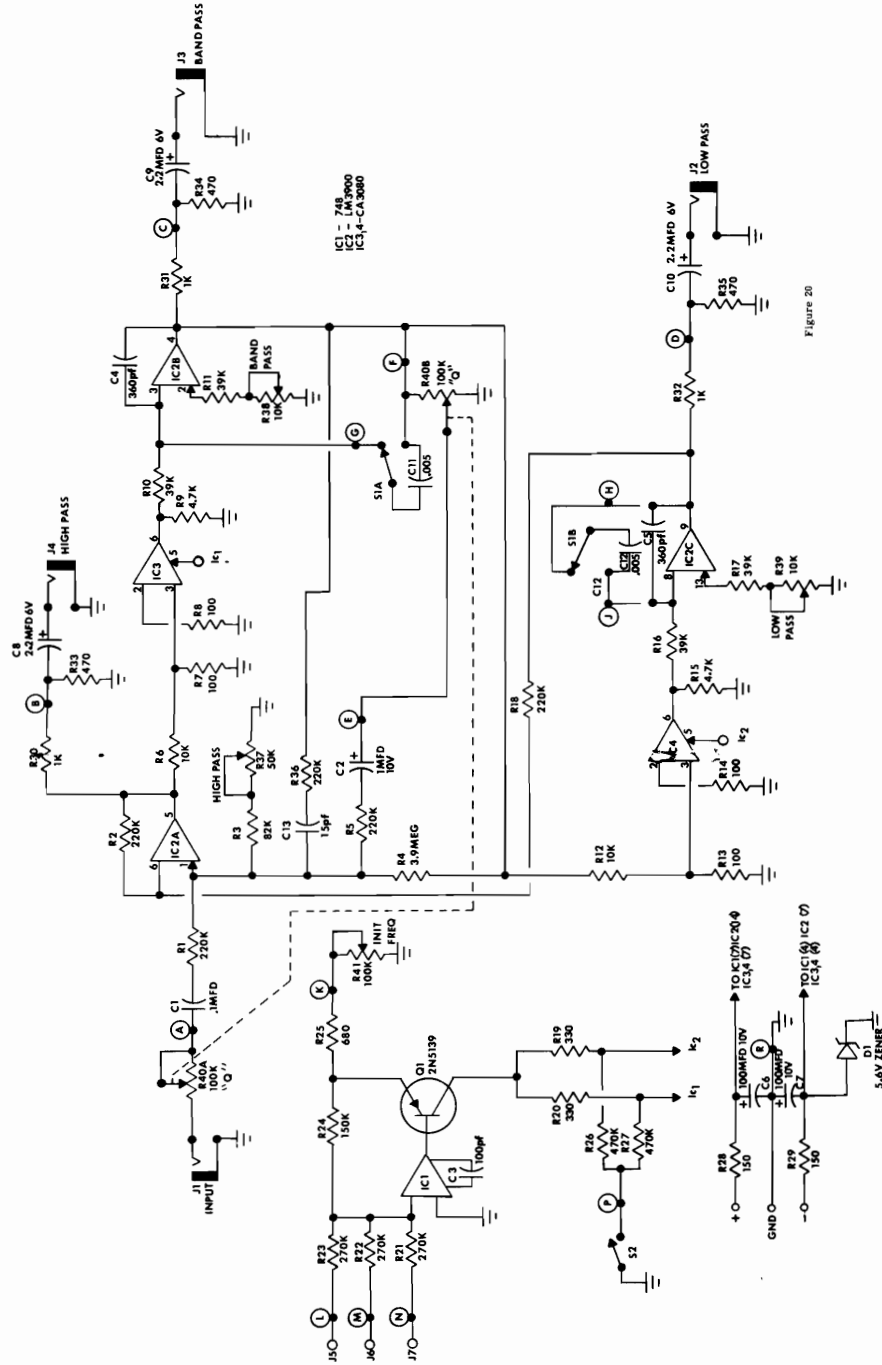

Figure 9 - Circuit board to front panel wiring detail. Previous wiring has been omitted for clarity.

4730 ASSEMBLY DRAWINGS

Remove this section for easy reference during assembly.



4730

A

D